

HART® field temperature transmitter Models TIF50, TIF52

WIKA data sheet TE 62.01



for further approvals
see page 10



Applications

- Plant construction
- Process engineering
- General industrial applications
- Oil and gas

Special features

- Setting of units and measuring range possible on site (only model TIF52)
- Different hazardous area approvals
- The following settings are possible via external software:
 - Dual sensor, redundant measurement possible
 - Customer-specific characteristic curves programmable



Field temperature transmitters models TIF50, TIF52

Description

The TIF series field temperature transmitters, consisting of a rugged field case, model T32 temperature transmitter and a model DIH display, have been designed for general use in process engineering.

They offer high accuracy, galvanic isolation and excellent protection against electromagnetic influences (EMI). Via HART® protocol, the TIFxx is configurable (interoperable) with a variety of open configuration tools.

In addition to the different sensor types, e.g. sensors in accordance with DIN EN 60751, JIS C1606, DIN 43760, IEC 60584 or DIN 43710, customer-specific sensor characteristics can also be defined, through the input of value pairs (user-defined linearisation).

Through the configuration of a sensor with redundancy (dual sensor), on a sensor failure it will automatically change over to the working sensor.

Furthermore, there is the possibility to activate sensor drift detection. With this, an error signalling occurs when the magnitude of the temperature difference between sensor 1 and sensor 2 exceeds a user-selectable value.

The field temperature transmitter also has additional sophisticated supervisory functionality such as monitoring of the sensor lead resistance and sensor-break detection in accordance with NAMUR NE89 as well as monitoring of the measuring range. Moreover, these transmitters have comprehensive cyclic self-monitoring functionality.

Via the display it is possible to show range alarms as well as MIN and MAX values.

The field temperature transmitter is available in various field case variants. Plastic, stainless steel and aluminium can be specified.

It can be mounted directly on a wall. A pipe mounting kit is also available for fitting to pipes with a diameter of 1 ... 2".

The field temperature transmitters are delivered with a basic configuration or configured according to customer specifications.

Specifications

Field temperature transmitter input							
		Max. configurable measuring range ¹⁾	Standard	α values	Minimum measuring span ¹⁴⁾	Typical measuring deviation ²⁾	Temperature coefficient per °C typical ³⁾
Resistance sensor	Pt100	-200 ... +850 °C	IEC 60751:2008	$\alpha = 0.00385$	10 K or 3.8 Ω (greater value applies)	$\leq \pm 0.12$ °C ⁵⁾	$\leq \pm 0.0094$ °C ^{6) 7)}
	Pt(x) ⁴⁾ 10 ... 1000	-200 ... +850 °C	IEC 60751:2008	$\alpha = 0.00385$		$\leq \pm 0.12$ °C ⁵⁾	$\leq \pm 0.0094$ °C ^{6) 7)}
	JPt100	-200 ... +500 °C	JIS C1606: 1989	$\alpha = 0.003916$		$\leq \pm 0.12$ °C ⁵⁾	$\leq \pm 0.0094$ °C ^{6) 7)}
	Ni100	-60 ... +250 °C	DIN 43760: 1987	$\alpha = 0.00618$		$\leq \pm 0.12$ °C ⁵⁾	$\leq \pm 0.0094$ °C ^{6) 7)}
	Resistance sensor	0 ... 8,370 Ω				4 Ω	$\leq \pm 1.68$ Ω ⁸⁾
	Potentiometer ⁹⁾	0 ... 100 %			10 %	≤ 0.50 % ¹⁰⁾	$\leq \pm 0.0100$ % ¹⁰⁾
Measuring current during measurement	Max. 0.3 mA (Pt100)						
Connection methods	1 sensor 2-/4-/3-wire or 2 sensors 2-wire (for further information, please refer to "Designation of connection terminals")						
Max. lead resistance	50 Ω each wire, 3-/4-wire						
Thermo-couple	Type J (Fe-CuNi)	-210 ... +1,200 °C	IEC 60584-1: 1995	50 K or 2 mV (greater value applies)	$\leq \pm 0.91$ °C ¹¹⁾	$\leq \pm 0.0217$ °C ^{7) 11)}	
	Type K (NiCr-Ni)	-270 ... +1,372 °C	IEC 60584-1: 1995		$\leq \pm 0.98$ °C ¹¹⁾	$\leq \pm 0.0238$ °C ^{7) 11)}	
	Type L (Fe-CuNi)	-200 ... +900 °C	DIN 43760: 1987		$\leq \pm 0.91$ °C ¹¹⁾	$\leq \pm 0.0203$ °C ^{7) 11)}	
	Type E (NiCr-Cu)	-270 ... +1,000 °C	IEC 60584-1: 1995		$\leq \pm 0.91$ °C ¹¹⁾	$\leq \pm 0.0224$ °C ^{7) 11)}	
	Type N (NiCrSi-NiSi)	-270 ... +1,300 °C	IEC 60584-1: 1995		$\leq \pm 1.02$ °C ¹¹⁾	$\leq \pm 0.0238$ °C ^{7) 11)}	
	Type T (Cu-CuNi)	-270 ... +400 °C	IEC 60584-1: 1995		$\leq \pm 0.92$ °C ¹¹⁾	$\leq \pm 0.0191$ °C ^{7) 11)}	
	Type U (Cu-CuNi)	-200 ... +600 °C	DIN 43710: 1985		$\leq \pm 0.92$ °C ¹¹⁾	$\leq \pm 0.0191$ °C ^{7) 11)}	
	Type R (PtRh-Pt)	-50 ... +1,768 °C	IEC 60584-1: 1995	150 K	$\leq \pm 1.66$ °C ¹¹⁾	$\leq \pm 0.0338$ °C ^{7) 11)}	
	Type S (PtRh-Pt)	-50 ... +1,768 °C	IEC 60584-1: 1995	150 K	$\leq \pm 1.66$ °C ¹¹⁾	$\leq \pm 0.0338$ °C ^{7) 11)}	
	Type B (PtRh-Pt)	0 ... +1,820 °C ¹⁵⁾	IEC 60584-1: 1995	200 K	$\leq \pm 1.73$ °C ¹¹⁾	$\leq \pm 0.0500$ °C ^{7) 12)}	
mV sensor	-500 ... +1,800 mV			4 mV	$\leq \pm 0.33$ mV ¹³⁾	$\leq \pm 0.0311$ mV ^{7) 13)}	
Connection methods	1 sensor or 2 sensors (for further information, please refer to "Designation of connection terminals")						
Max. lead resistance	5 k Ω each wire						
Cold junction compensation, configurable	internal compensation or external with Pt100, with thermostat or off						

1) Other units e.g. °F and K possible

2) Measuring deviations (input + output) at ambient temperature 23 °C \pm 3 K, without influence of lead resistances; for example calculations see page 5

3) Temperature coefficients (input + output) per °C

4) x configurable between 10 ... 1,000

5) Based on 3-wire Pt100, Ni100, 150 °C MV

6) Based on 150 °C MV

7) In the ambient temperature range -40 ... +85 °C

8) Based on a sensor with max. 5 k Ω

9) Rtotal: 10 ... 100 k Ω

10) Based on a potentiometer value of 50 %

11) Based on 400 °C MV with cold junction compensation error

12) Based on 1.000 °C MV with cold junction compensation error

13) Based on measuring range 0 ... 1 V, 400 mV MV

14) The transmitter can be configured below these limits, but this is not recommended due to loss of accuracy.

15) Specifications valid only for measuring range between 450 ... 1,820 °C

MV = measured value (temperature measured values in °C)

Note:

The transmitter can be configured below these limits, but this is not recommended due to loss of accuracy.

The selection of the sensor is only possible via the HART® software (e.g. WIKA_T32) or the HART® communicator (e.g. FC475, MFC4150).

WIKA configuration software WIKA_T32: Free download from www.wika.com

User linearisation

Via software, customer-specific sensor characteristics can be stored in the transmitter, so that further sensor types can be used. Number of data points: Minimum 2; maximum 30

Monitoring functionality with 2 sensors connected (dual sensor)

Redundancy

In the case of a sensor error (sensor break, lead resistance too high or outside the measuring range of the sensor) of one of the two sensors, the process value will be only based on the error-free sensor. Once the error is rectified, the process value will again be based on the two sensors or on sensor 1.

Ageing control (sensor-drift monitoring)

An error signal on the output is activated if the value of the temperature difference between sensor 1 and sensor 2 is higher than a set value, which can be selected by the user. This monitoring only generates a signal if two valid sensor values can be determined and the temperature difference is higher than the selected limit value.
(Cannot be selected for the "Difference" sensor function, since the output signal already indicates the difference value).

Sensor functionality when 2 sensors have been connected (dual sensor)

Sensor 1, sensor 2 redundant

The 4 ... 20 mA output signal delivers the process value of sensor 1. If sensor 1 fails, the process value of sensor 2 is output (sensor 2 is redundant).

Mean value

The 4 ... 20 mA output signal delivers the mean value of the two values from sensor 1 and sensor 2. If one sensor fails, the process value of the error-free sensor is output.

Minimum value



The 4 ... 20 mA output signal delivers the lower of the two values from sensor 1 and sensor 2. If one sensor fails, the process value of the error-free sensor is output.

Maximum value

The 4 ... 20 mA output signal delivers the higher of the two values from sensor 1 and sensor 2. If one sensor fails, the process value of the error-free sensor is output.

Difference

The 4 ... 20 mA output signal delivers the difference between sensor 1 and sensor 2. If one sensor fails, an error signalling will be activated.

Display / operating unit	Model TIF50	Model TIF52
Display principle	LCD, rotatable in 10° steps	
Measured value of display	7-segment LCD, 5-digit, character size 9 mm	
Bar graph	20-segment LCD	
Info line	14-segment LCD, 6-digit, character size 5.5 mm	
Status indicators	 : HART® mode (signalling of HART® parameter adoption)  : Unit lock  : Warnings or error messages	
Indication range	-9999 ... 99999	
Measuring rate	approx. 4/s	
Accuracy	±0.1 % of measuring span	±0.05 % of measuring span
Temperature coefficient	±0.1 % of measuring span / 10 K	
HART® functionality		
■ Access control	-	Secondary master
■ Automatically set parameters		
■ Available commands	-	Unit, measuring range start/end, format, zero point, span, damping, polling address
■ Identified commands	Generic mode: 1, 15, 35, 44	Generic mode: 0, 1, 6, 15, 34, 35, 36, 37, 44
■ Multidrop	Not supported	Measured values are automatically taken from the HART® digital data and displayed

Rise time / damping / measuring rate

Rise time t_{90}	Approx. 0.8 s
Damping , configurable	Off ; configurable between 1 s and 60 s
Switch-on time (time to get the first measured value)	Max. 15 s
Measuring rate ¹⁾	Measured value update approx. 3/s

Bold: Basic configuration

1) Valid only for RTD/single thermocouple sensor

Analogue output / output limits / signalling / insulation resistance

Analogue output , configurable	Linear to temperature per IEC 60751 / JIS C1606 / DIN 43760 (for resistance sensors) or linear to temperature per IEC 584 / DIN 43710 (for thermocouples) 4 ... 20 mA or 20 ... 4 mA, 2-wire	
Output limits , configurable per NAMUR NE43 customer-specifically adjustable	Lower limit 3.8 mA 3.6 ... 4.0 mA	upper limit 20.5 mA 20.0 ... 21.5 mA
Current value for signalling , configurable per NAMUR NE43 Substitute value	Downscale < 3.6 mA (3.5 mA) 3.5 ... 12.0 mA	upscale > 21.0 mA (21.5 mA) 12.0 ... 23.0 mA
In simulation mode, independent from input signal, simulation value configurable from 3.5 ... 23.0 mA		
Load R_A (without HART®)	$R_A \leq (U_B - 13.5 \text{ V}) / 0.023 \text{ A}$ with R_A in Ω and U_B in V	
Load R_A (with HART®)	$R_A \leq (U_B - 14.5 \text{ V}) / 0.023 \text{ A}$ with R_A in Ω and U_B in V	
Insulation voltage (input to analogue output)	AC 1,200 V (50 Hz / 60 Hz); 1 s	
Insulation specification to DIN EN 60664-1:2003	Overvoltage category III	

Bold: Basic configuration

Explosion protection / power supply

Model	Approvals	Permissible ambient/storage temperature (in accordance with the relevant temperature classes)	Safety-related maximum values		Power supply U_B (DC)
			Sensor (Connections 1 - 4)	Current loop (Connections \pm)	
TIF50-S , TIF52-S	without	{-50} -40 ... +85 °C	-	-	14.5 ... 42 V
TIF50-F , TIF52-F	Flameproof enclosure BVS 10 ATEX E 158 IECEX BVS 10.0103 II 2G Ex db IIC T4/T5/T6 Gb Ex db IIC T4/T5/T6 Gb	-40 ... +85 °C at T4 -40 ... +75 °C at T5 -40 ... +60 °C at T6	-	$U_M = 30 \text{ V}$ $P_M = 2 \text{ W}$	14.5 ... 30 V
TIF50-F , TIF52-F	Flameproof enclosure TC RU C-DE.ГБ08.V.02128 1 Ex d IIC T6 ... T4	-60 ²⁾ / -40 ... +85 °C at T4 -60 ²⁾ / -40 ... +75 °C at T5 -60 ²⁾ / -40 ... +60 °C at T6	-	$U_M = 30 \text{ V}$ $P_M = 2 \text{ W}$	14.5 ... 30 V
TIF50-I , TIF52-I	Intrinsically safe equipment ¹⁾ BVS 16 ATEX E 112 X IECEX BVS 16.0075X II (1)2G Ex ia [ia Ga] IIC T4/T5/T6 Gb II (1)2D Ex ia [ia Da] IIIC T135 °C Db II 2D Ex ia IIC T4/T5/T6 Gb II 2D Ex ia IIIC T135 °C Db	-40 ... +85 °C at T4 -40 ... +70 °C at T5 -40 ... +55 °C at T6 -40 ... +40 °C ($P_i = 680 \text{ mW}$) -40 ... +70 °C ($P_i = 650 \text{ mW}$)	see installation drawing in the operating instructions at www.wika.com	see installation drawing in the operating instructions at www.wika.com	14.5 ... 29 V
TIF50-I , TIF52-I	Intrinsically safe equipment ¹⁾ TC RU C-DE.ГБ08.V.02128 0 Ex ia IIC T4/T5/T6 1 Ex ib [ia] IIC T4/T5/T6 DIP A20 Ta 120 °C DIP A21 Ta 120 °C	-60 ²⁾ / -40 ... +85 °C at T4 -60 ²⁾ / -40 ... +70 °C at T5 -60 ²⁾ / -40 ... +55 °C at T6 -60 ²⁾ / -40 ... +40 °C ($P_i = 680 \text{ mW}$) -60 ²⁾ / -40 ... +70 °C ($P_i = 650 \text{ mW}$)	see installation drawing in the operating instructions at www.wika.com	see installation drawing in the operating instructions at www.wika.com	14.5 ... 29 V

1) The installation conditions for the transmitters and displays must be considered for the final application.

2) Special version on request (only available with specific approvals)

Measuring deviation, temperature coefficient, long-term stability

Effect of load	Not measurable				
Power supply effect	Not measurable				
Warm-up time	After approx. 5 minutes the instrument will function to the specifications (accuracy)				
Input	Measuring deviation per DIN EN 60770, 23 °C ± 3 K	Mean temperature coefficient (TC) for each 10 K change in ambient temperature in the range -40 ... +85 °C	Lead resistance effects	Long-term stability after 1 year	
■ Resistance thermometer Pt100/JPt100/ Ni100 ¹⁾	-200 °C ≤ MV ≤ 200 °C: ±0.10 K MV > 200 °C: ±(0.1 K + 0.01 % IMV - 200 KI) ²⁾	±(0.06 K + 0.015 % MV)	4-wire: no effect (0 to 50 Ω each wire) 3-wire: ±0.02 Ω / 10 Ω (0 to 50 Ω each wire) 2-wire: Resistor of the connection lead ³⁾	±60 mΩ or 0.05 % of MV, greater value applies	
■ Resistance sensor	≤ 890 Ω: 0.053 Ω ⁴⁾ or 0.015 % MV ⁵⁾ ≤ 2,140 Ω: 0.128 Ω ⁴⁾ or 0.015 % MV ⁵⁾ ≤ 4,390 Ω: 0.263 Ω ⁴⁾ or 0.015 % MV ⁵⁾ ≤ 8,380 Ω: 0.503 Ω ⁴⁾ or 0.015 % MV ⁵⁾	±(0.01 Ω + 0.01 % MV)			
■ Potentiometer	R _{part} /R _{total} is max. ±0.5 %	±(0.1 % MV)		±20 μV or 0.05 % of MV, greater value applies	
■ Thermocouples Type E, J	-150 °C < MV < 0 °C: ±(0.3 K + 0.2 % IMV) MV > 0 °C: ±(0.3 K + 0.03 % MV)	Type E: MV > -150 °C: ±(0.1 K + 0.015 % IMV) Type J: MV > -150 °C: ±(0.07 K + 0.02 % IMV)	6 μV / 1,000 Ω ⁶⁾		
Type T, U	-150 °C < MV < 0 °C: ±(0.4 K + 0.2 % IMV) MV > 0 °C: ±(0.4 K + 0.01 % MV)	-150 °C < MV < 0 °C: ±(0.07 K + 0.04 % MV) MV > 0 °C: ±(0.07 K + 0.01 % MV)			
Type R, S	50 °C < MV < 400 °C: ±(1.45 K + 0.12 % IMV - 400 KI) 400 °C < MV < 1,600 °C: ±(1.45 K + 0.01 % IMV - 400 KI)	Type R: 50 °C < MV < 1,600 °C: ±(0.3 K + 0.01 % IMV - 400 KI) Type S: 50 °C < MV < 1,600 °C: ±(0.3 K + 0.015 % IMV - 400 KI)			
Type B	450 °C < MV < 1,000 °C: ±(1.7 K + 0.2 % IMV - 1,000 KI) MV > 1,000 °C: ±1.7 K	450 °C < MV < 1,000 °C: ±(0.4 K + 0.02 % IMV - 1,000 KI) MV > 1,000 °C: ±(0.4 K + 0.005 % (MV - 1,000 K))			
Type K	-150 °C < MV < 0 °C: ±(0.4 K + 0.2 % IMV) 0 °C < MV < 1,300 °C: ±(0.4 K + 0.04 % MV)	-150 °C < MV < 1,300 °C: ±(0.1 K + 0.02 % IMV)			
Type L	-150 °C < MV < 0 °C: ±(0.3 K + 0.1 % IMV) MV > 0 °C: ±(0.3 K + 0.03 % MV)	-150 °C < MV < 0 °C: ±(0.07 K + 0.02 % IMV) MV > 0 °C: ±(0.07 K + 0.015 % MV)			
Type N	-150 °C < MV < 0 °C: ±(0.5 K + 0.2 % IMV) MV > 0 °C: ±(0.5 K + 0.03 % MV)	-150 °C < MV < 0 °C: ±(0.1 K + 0.05 % IMV) MV > 0 °C: ±(0.1 K + 0.02 % MV)			
■ mV sensor	≤ 1,160 mV: 10 μV + 0.03 % IMV > 1,160 mV: 15 μV + 0.07 % IMV	2 μV + 0.02 % IMV 100 μV + 0.08 % IMV			
■ Cold junction ⁷⁾	±0.8 K	±0.1 K			
Output	±0.03 % of measuring span	±0.03 % of measuring span			±0.05 % of span

Total measuring deviation

Addition: Input + output per DIN EN 60770, 23 °C ± 3 K

MV = measured value (temperature measured values in °C)

Measuring span = configured end of measuring range - configured start of measuring range

- For sensor Ptx (x = 10 ... 1,000) applies:
for x ≥ 100: Permissible error, as for Pt100
for x < 100: Permissible error, as for Pt100 with a factor (100/x)
- Additional error for resistance thermometers in a 3-wire configuration with zero-balanced cable: 0.05 K
- The specified resistance value of the sensor wire can be subtracted from the calculated sensor resistance.
Dual sensor: Configurable for each sensor separately
- Double value at 3-wire

- Greater value applies
- Within a range of 0 ... 10 kΩ lead resistance
- Only for thermocouple

Basic configuration:
Input signal: Pt100 in 3-wire connection, measuring range: 0 ... 150 °C

Example calculation

Pt100 / 4-wire / measuring range 0 ... 150 °C / ambient temperature 33 °C	
Input Pt100, MV < 200 °C	±0.100 K
Output ±(0.03 % of 150 K)	±0.045 K
TC 10 K - input ±(0.06 K + 0.015 % of 150 K)	±0.083 K
TC 10 K - output ±(0.03 % of 150 K)	±0.045 K
Measuring deviation (typical) $\sqrt{\text{input}^2 + \text{output}^2 + \text{TC}_{\text{input}}^2 + \text{TC}_{\text{output}}^2}$	±0.145 K
Measuring deviation (maximum) (input + output + TC _{input} + TC _{output})	±0.273 K

Thermocouple type K / measuring range 0 ... 400 °C / internal compensation (cold junction) / ambient temperature 23 °C	
Input type K, 0 °C < MV < 1,300 °C ±(0.4 K + 0.04 % of 400 K)	±0.56 K
Cold junction ±0.8 K	±0.80 K
Output ±(0.03 % of 400 K)	±0.12 K
Measuring deviation (typical) $\sqrt{\text{input}^2 + \text{cold junction}^2 + \text{output}^2}$	±0.98 K
Measuring deviation (maximum) (input + cold junction + output)	±1.48 K

Monitoring	
Test current for sensor monitoring ¹⁾	Nom. 20 µA during test cycle, otherwise 0 µA
Monitoring NAMUR NE89 (monitoring of input lead resistance)	
■ Resistance thermometer (Pt100, 4-wire)	R _{L1} + R _{L4} > 100 Ω with hysteresis 5 Ω R _{L2} + R _{L3} > 100 Ω with hysteresis 5 Ω
■ Thermocouple	R _{L1} + R _{L4} + R _{thermocouple} > 10 kΩ with hysteresis 100 Ω
Sensor break monitoring	Always active
Self-monitoring	Active permanently, e.g. RAM/ROM test, logical program operating checks and validity check
Measuring range monitoring	Monitoring of the set measuring range for upper/lower deviations Standard: Deactivated
Monitoring of input lead resistance (3-wire)	Monitoring of the resistance difference between lead 3 and 4; an error will be indicated if there is a difference of > 0.5 Ω between leads 3 and 4

1) Only for thermocouple

Field case	
Material	■ Aluminium, window from polycarbonate ■ Stainless steel, window from polycarbonate
Colour	Aluminium: Night blue, RAL 5022 Stainless steel: Silver
Cable bushings	3 x M20 x 1.5 or 3 x ½ NPT
Ingress protection	IP66
Weight	Aluminium: approx. 1.5 kg Stainless steel: approx. 3.7 kg
Dimensions	See drawing

Ambient conditions	
Ambient temperature	-60 ¹⁾ / -40 ... +85 °C
Functional area of the display	-20 ²⁾ ... +70 °C
Climate class per IEC 654-1: 1993	Cx (-20 ... +85 °C, 35 ... 85 % r. h., non-condensing)
Maximum permissible humidity	93 % r. h. ±3 %
Vibration resistance per IEC 60068-2-6:2007	3 g
Shock resistance per IEC 68-2-27: 1987	30 g
Electromagnetic compatibility (EMC)	EN 61326 emission (group 1, class B) and interference immunity (industrial application), and also NAMUR NE21

1) Special version on request (only available with specific approvals)

2) In previous ambient temperatures < -20 °C a delayed recovery of the indication function could be expected, especially in case of low loop current.

Communication HART® protocol rev. 5 including burst mode and multidrop

Interoperability (i.e. compatibility between components from different manufacturers) is a strict requirement of HART® instruments. The field transmitter is compatible with almost every open software and hardware tool; among other things with:

1. User-friendly WIKA configuration software, free-of-charge download via www.wika.com
2. HART® communicator HC275 / FC375 / FC475 / MFC4150:
 - T32 device description integrated
3. Asset Management Systems
 - 3.1 AMS: T32_DD completely integrated and upgradable with old versions
 - 3.2 Simatic PDM: T32_EDD completely integrated from version 5.1, upgradable with version 5.0.2
 - 3.3 Smart Vision: DTM upgradable per FDT standard from SV version 4
 - 3.4 PACTware (see accessories): DTM completely integrated and upgradable as well as all supporting applications with FDT interface
 - 3.5 Field Mate: DTM upgradable

Attention:

For direct communication via the serial interface of a PC/notebook, a HART® modem is needed (see "Accessories").

As a general rule, parameters which are defined in the scope of the universal HART® commands (e.g. the measuring range) can, in principle, be edited with all HART® configuration tools.

Load diagram

The permissible load depends on the loop supply voltage.

Load $R_A \leq (U_B - 13.5 \text{ V}) / 0.023 \text{ A}$ with R_A in Ω and U_B in V (without HART®)

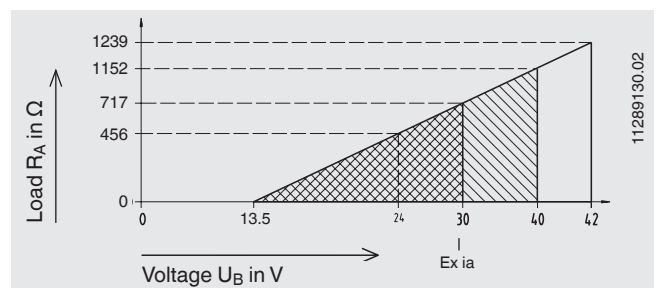

Designation of connection terminals

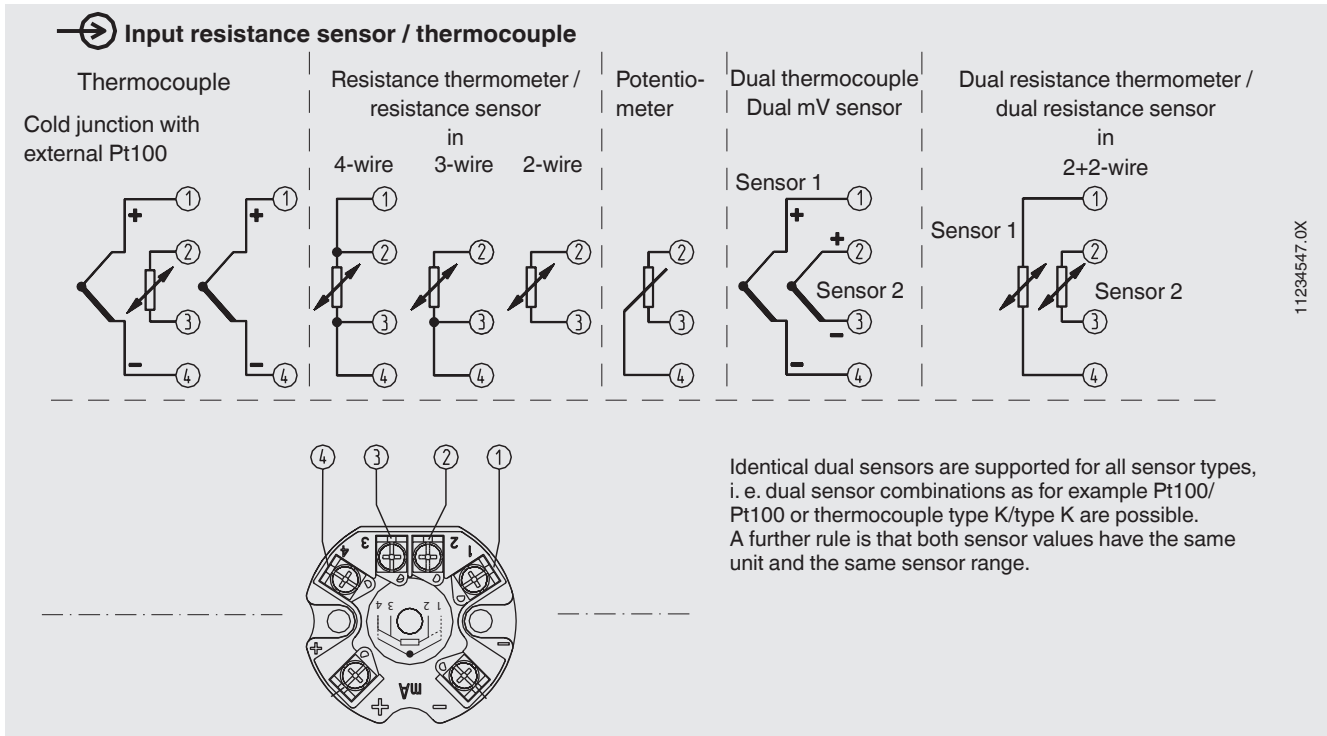

Electrical connection

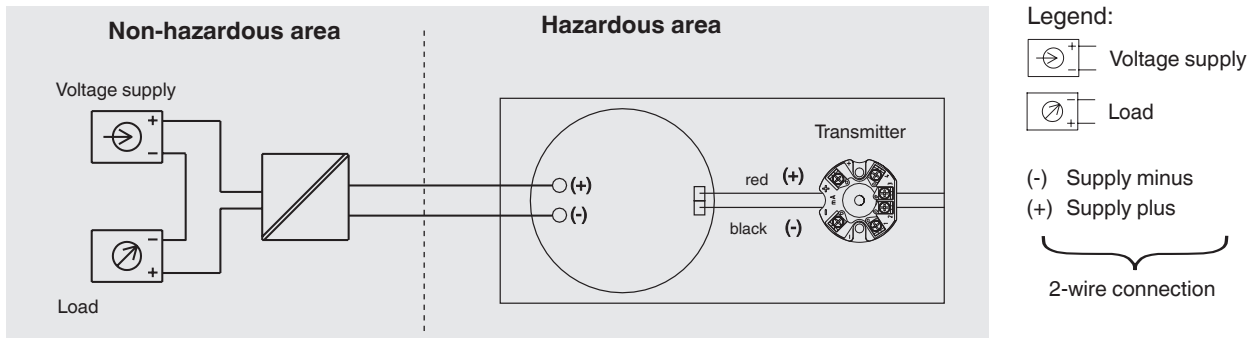



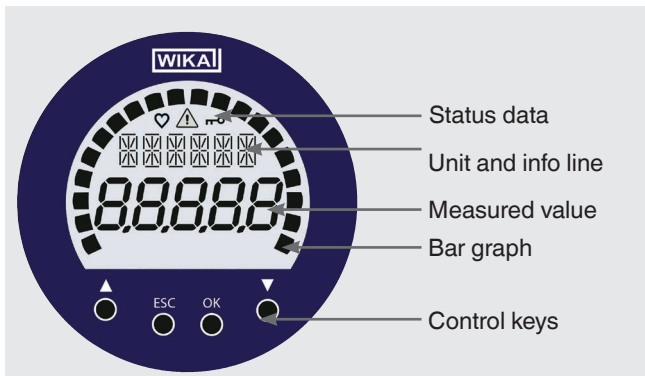

User interface

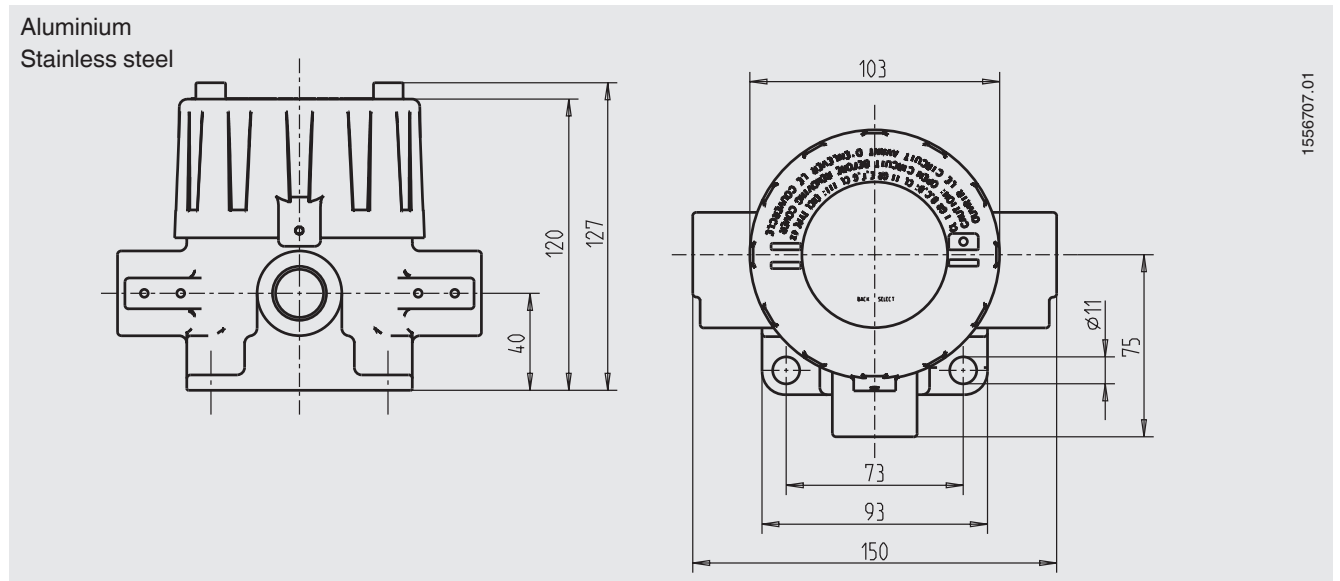









Dimensions in mm



Accessories

Model	Special features	Order No.
Model 010031 	HART® modem for USB interface, specifically designed for use with modern notebooks	11025166
Model 010001	HART® modem for RS-232 interface	7957522
Model 010041	HART® modem for Bluetooth interface [Ex ia] IIC	11364254
FC475HP1EKLUGMT 	HART® protocol, Li-Ion battery, voltage supply AC 90 ... 240 V, without EASY UPGRADE; ATEX, FM and CSA (intrinsically safe)	on request
FC475FP1EKLUGMT	HART® protocol, FOUNDATION™ Fieldbus, Li-Ion battery, voltage supply AC 90 ... 240 V, with EASY UPGRADE; ATEX, FM and CSA (intrinsically safe)	on request
MFC5150 	HART® protocol, universal voltage supply, cable set with 250 Ω resistor, with explosion protection	on request
Magnetic quick connector magWIK 	<ul style="list-style-type: none"> ■ Replacement for crocodile clips and HART® terminals ■ Fast, safe and tight electrical connection ■ For all configuration and calibration processes 	14026893

Approvals

Logo	Description	Country
	EU declaration of conformity <ul style="list-style-type: none"> ■ EMC directive EN 61326 emission (group 1, class B) and interference immunity (industrial application) ■ ATEX directive (option) Hazardous areas 	European Union
		
	IECEx (option) Hazardous areas	International
	EAC (option) <ul style="list-style-type: none"> ■ EMC directive ■ Hazardous areas 	Eurasian Economic Community
	GOST (option) Metrology, measurement technology	Russia
	KazInMetr (option) Metrology, measurement technology	Kazakhstan
-	MTSCHS (option) Permission for commissioning	Kazakhstan
	BelGIM (option) Metrology, measurement technology	Belarus
	DNOP - MakNII (option) <ul style="list-style-type: none"> ■ Mining ■ Hazardous areas 	Ukraine
-	PESO (option) Hazardous areas	India

Certificates (option)

- 2.2 test report
- 3.1 inspection certificate
- DKD/DAkS calibration certificate

Approvals and certificates, see website

Ordering information

Model / Indicator module / Explosion protection / Case material / Transmitter / Cable bushings / Threaded connection for cable bushing / Certificates / Options

© 04/2011 WIKA Alexander Wiegand SE & Co. KG, all rights reserved.
 The specifications given in this document represent the state of engineering at the time of publishing.
 We reserve the right to make modifications to the specifications and materials.

