

# Hand-held multifunction calibrator

## Models Pascal ET, Pascal ET/IS

WIKA data sheet CT 18.02



### Applications

- Calibration service companies and service industry
- Measurement and control laboratories
- Quality assurance

### Special features

- Measurement and simulation of the following parameters: pressure, electrical signals (mA, mV, V,  $\Omega$ ), temperature (TC, RTD), frequency and pulse
- Large colour display with touchscreen with new intuitive and user-friendly interface
- Integrated data logger and calibration function
- Option: intrinsically safe version, II 2G Ex ib IIC T4 Gb -  $T_{amb}$ : -10 ... +50 °C
- Option: integrated HART® module for communication with HART® instruments



Hand-held multifunction calibrator, model Pascal ET/IS

## Description

### General

Due to its versatility the hand-held multifunction calibrator Pascal series is ideally suited for on-field testing and calibration of industrial measuring instruments. The typical application is the calibration of pressure transmitters, temperature transmitters, pressure gauges, temperature probes and other measuring instruments. The calibration data are stored in the instrument's memory. The communication with a PC is used to remotely control the unit and to download the calibration reports.

The Pascal ET is the most advanced portable multifunction calibrator for the measurement and simulation of the following parameters: relative and absolute pressure, electrical signals (mA, mV, V,  $\Omega$ ), temperature (TC, RTD), frequency and pulse. In addition, there is the possibility to include an optional HART® module which allows communication with HART® instruments.

### Features

The calibrator Pascal ET has a new large colour touchscreen display with a new intuitive and user-friendly interface, that allows an easy and fast configuration of the calibrator. The availability of ATEX approval II 2G Ex ib IIC T4 Gb -  $T_{amb}$ : -10 ... +50 °C expands the possible applications of this calibrator into hazardous areas (only for Pascal ET/IS). Even in the ATEX version the DC 24 V voltage supply for external transmitters is available.

The calibrator has four measurement channels and is thus capable to carry out up to four simultaneous measures. For more flexibility on on-field calibrations, the Pascal ET has an on-board memory for data storage that allows the evaluation of logged measuring values and calibration reports. In laboratory applications the real-time communication allows the remote control of the Pascal ET from a PC.

The Pascal ET can be modularly configured with up to two input and two output modules as well as one HART® module and one output module, which are galvanically isolated from each other. The measurement/simulation of the electrical signals or temperature as well as up to two external pressure sensors enables the operator to configure the calibrator according to his specific requirements.

The environmental parameters module (option) is another plus of Pascal ET, it allows the monitoring of the barometric pressure, the ambient temperature and the relative humidity. The values will be stored in the calibration report.

## Specifications





### Models Pascal ET and Pascal ET/IS

Base instrument	
<b>Indication</b>	
Display	Touchscreen + 5 keys
Dimensions	640 x 480 Dots Dot size: 0.06 x 0.06 mm (0.002 x 0.002 in)
Backlight	LED
<b>Electrical input and output</b>	
Number and type	banana-plug inputs for electrical parameters, resistance thermometers and thermocouples
Resistance thermometer (RTD)	Pt100 (385, 3616, 3906, 3926, 3923), Pt200, Pt500, Pt1000 (385, 3916), Ni100, Ni120, Cu10, Cu100
Thermocouples	Types J, K, T, F, R, S, B, U, L, N, E, C
Voltage signal	input: DC $\pm 100$ mV, $\pm 2$ V, $\pm 80$ V output: DC 20 V
Current signal	input: DC $\pm 100$ mA output: DC 20 mA
Frequency signal	0 ... 50,000 Hz
Pulses signal	1 ... 999,999
Resistance	0 ... 10,000 $\Omega$
Voltage supply	DC 24 V
<b>HART® communication</b>	
HART® module	based on HART® universal and common practice commands
Resistance	HART® resistance 250 $\Omega$ (activatable)
Loop current	max. DC 24 mA
Voltage supply	DC 24 V
<b>Pressure connection</b>	1/4" BSP (male) by PSP-1 external pressure sensor
<b>Permissible media</b>	non-corrosive gases and liquids
<b>Temperature compensation</b>	-10 ... +50 °C (14 ... 122 °F)
<b>Temperature coefficient</b>	0.001 % of reading/°C, outside of 19 ... 23 °C (66 ... 73 °F)
<b>Units</b>	bar, mbar, psi, psf, Pa, hPa, kPa, MPa, torr, atm, kg/cm <sup>2</sup> , kg/m <sup>2</sup> , mmHg (0 °C), cmHg (0 °C), mHg (0 °C), inHg (0 °C), mmH <sub>2</sub> O (4 °C), cmH <sub>2</sub> O (4 °C), mH <sub>2</sub> O (4 °C), inH <sub>2</sub> O (4 °C), ftH <sub>2</sub> O (4 °C)
<b>Voltage supply</b>	
Battery type	rechargeable battery NiMH
Battery life (fully-charged)	8 hours for typical usage (without backlighting)
Power supply	AC 100 ... 240 V, 50/60 Hz
<b>Permissible ambient conditions</b>	
Operating temperature	-10 ... +50 °C (14 ... 122 °F)
Storage temperature	-30 ... +80 °C (-22 ... +176 °F)
Relative humidity	Operating humidity: 10 ... 90 % r. h. (non-condensing) Storage humidity: 0 ... 90 % r. h. (non-condensing)

Case	
Material	Front panel aluminium
Ingress protection	IP54
Dimensions	305 x 210 x 90 mm (12 x 8.27 x 3.55 in)
Weight	approx. 3 kg (6 lbs 6 oz)

Ignition protection type for model Pascal ET/IS	
<b>ATEX directive</b>	II 2G Ex ib IIC T4 Gb - T <sub>amb</sub> : -10 ... +50 °C
<b>Connection values</b>	
Max. voltage	U <sub>0</sub> = 29.7 V
Max. current	I <sub>0</sub> = 31 mA
Max. power	P <sub>0</sub> = 0.92 W
Max. effective internal capacitance	C <sub>0</sub> = 69 nF
Max. effective internal inductance	L <sub>0</sub> = 30 mH
<b>Power supply circuit</b>	
Max. voltage	U <sub>i</sub> = 30 V
Max. current	I <sub>i</sub> = 100 mA
Max. power	P <sub>i</sub> = 0.75 W
Max. effective internal capacitance	C <sub>i</sub> = negligible
Max. effective internal inductance	L <sub>i</sub> = negligible

## Approvals

Logo	Description	Country
	<b>EU declaration of conformity</b> <ul style="list-style-type: none"> <li>■ EMC directive EN 61326 emission (group 1, class B) and interference immunity (portable test and measuring equipment)</li> <li>■ ATEX directive II 2G Ex ib IIC T4 Gb - T<sub>amb</sub>: -10 ... +50 °C</li> </ul>	European Union
	<b>IECEx</b> Hazardous areas Ex ib IIC T4 Gb - T <sub>amb</sub> : -10 ... +50 °C	International
	<b>EAC</b> <ul style="list-style-type: none"> <li>■ Electromagnetic compatibility</li> <li>■ Low voltage directive</li> </ul>	Eurasian Economic Community
	<b>DNOP-MakNII</b> Hazardous areas	Ukraine
	<b>BelGIM</b> Metrology, measurement technology	Belarus

## Certificates

Certificate	
<b>Calibration</b>	3.1 calibration certificate per DIN EN 10204 option: ACCREDIA calibration certificate
<b>Recommended recalibration interval</b>	1 year (dependent on conditions of use)

Approvals and certificates, see website

## Pressure module

### External sensors

(other pressure ranges available on request)

- One year specifications
- Temperature effect:  $0.002\% \text{ of reading} \cdot |t - t_c|$  for  $t: 0\text{ °C} \leq t \leq 18\text{ °C}$  and  $28\text{ °C} \leq t \leq 50\text{ °C}$  and  $t_c = 20\text{ °C}$   
 $32\text{ °F} \leq t \leq 64.4\text{ °F}$  and  $82.4\text{ °F} \leq t \leq 122\text{ °F}$  and  $t_c = 68\text{ °F}$
- Process connection: 1/4" BSP male

Measuring range		Precision (% FS)	Accuracy (% FS)	Resolution
<b>Relative pressure</b>				
-60 ... +60 mbar	(-0.9 ... 0.9 psi)	0.1	0.15	0.001 mbar (0.00001 psi)
-500 ... +500 mbar	(-7.3 ... 7.3 psi)	0.015	0.025	0.001 mbar (0.00001 psi)
-900 ... +1,500 mbar	(-13.1 ... 21.8 psi)	0.015	0.025	0.01 mbar (0.0001 psi)
0 ... 7 bar	(0 ... 100 psi)	0.015	0.025	0.1 mbar (0.001 psi)
0 ... 21 bar	(0 ... 305 psi)	0.015	0.025	0.1 mbar (0.001 psi)
0 ... 50 bar	(0 ... 725 psi)	0.015	0.025	1 mbar (0.015 psi)
0 ... 100 bar	(0 ... 1,450 psi)	0.015	0.025	1 mbar (0.015 psi)
0 ... 200 bar	(0 ... 2,900 psi)	0.015	0.025	10 mbar (0.145 psi)
0 ... 400 bar	(0 ... 5,800 psi)	0.015	0.025	100 mbar (1.45 psi)
0 ... 700 bar	(0 ... 10,150 psi)	0.025	0.05	100 mbar (1.45 psi)
0 ... 1,000 bar	(0 ... 14,500 psi)	0.025	0.05	100 mbar (1.45 psi)
<b>Absolute pressure</b>				
0 ... 1,500 mbar abs.	(0 ... 21.8 psi)	0.015	0.025	0.01 mbar (0.0001 psi)
0 ... 2,500 mbar abs.	(0 ... 36.3 psi)	0.015	0.025	0.01 mbar (0.0001 psi)
0 ... 5 bar abs.	(0 ... 72.5 psi abs.)	0.015	0.025	0.1 mbar (0.001 psi)
0 ... 7 bar abs.	(0 ... 100 psi abs.)	0.015	0.025	0.1 mbar (0.001 psi)
0 ... 21 bar abs.	(0 ... 305 psi abs.)	0.015	0.025	0.1 mbar (0.001 psi)
0 ... 81 bar abs.	(0 ... 1,175 psi abs.)	0.015	0.025	1 mbar (0.015 psi)
0 ... 100 bar abs.	(0 ... 1,450 psi abs.)	0.015	0.025	1 mbar (0.015 psi)

## Electrical input signal

Electrical signal	Measuring range	Full scale	Precision % of rdg ±% FS	Accuracy % of rdg ±% FS	Max. resolution
<b>Voltage DC 1) 2)</b>	±100 mV 3)	100 mV	0.008 % ±0.002 % FS	0.01 % ±0.003 % FS	0.0001 mV
	±2 V 3)	2 V	0.008 % ±0.002 % FS	0.01 % ±0.003 % FS	0.000001 V
	±80 V 4)	80 V	0.008 % ±0.002 % FS	0.01 % ±0.003 % FS	0.00001 V
<b>Current DC 1) 5)</b>	±100 mA	100 mA	0.008 % ±0.003 % FS	0.01 % ±0.003 % FS	0.0001 mA
<b>Resistance 1) 6)</b>	0 ... 400 Ω	400 Ω	0.008 % ±0.002 % FS	0.01 % ±0.003 % FS	0.001 Ω
	0 ... 10,000 Ω	10,000 Ω	0.008 % ±0.002 % FS	0.01 % ±0.003 % FS	0.01 Ω
<b>Frequency 7)</b>	0.5 ... 10,000 Hz 8)	50,000 Hz	0.01 Hz	0.01 Hz	0.001 Hz
	10,000 ... 20,000 Hz 8)	50,000 Hz	0.1 Hz	0.1 Hz	0.001 Hz
	20,000 ... 30,000 Hz 9)	50,000 Hz	1 Hz	1 Hz	0.001 Hz
	30,000 ... 50,000 Hz 9)	50,000 Hz	20 Hz	20 Hz	0.001 Hz
<b>Pulses 10)</b>	1 ... 999,999	999,999	N/A	N/A	1

1) One year specifications with temperature effect:  $0.001\% \text{ of reading} \cdot |t - t_c|$  for  $t: -10\text{ °C} \leq t \leq 19\text{ °C}$  and  $23\text{ °C} \leq t \leq 50\text{ °C}$  and  $t_c = 20\text{ °C}$   
 $14\text{ °F} \leq t \leq 66.2\text{ °F}$  and  $73.4\text{ °F} \leq t \leq 122\text{ °F}$  and  $t_c = 68\text{ °F}$

2) Maximum input voltage: DC ±100 V

3) Input impedance: > 100 MΩ

4) Input impedance: 0.5 MΩ

5) Maximum input current: ±120 mA; Input impedance: < 20 Ω

6) Measure current: < 200 μA

7) Maximum input voltage: ±100 V; Input impedance: > 100 MΩ

Minimum amplitude of square wave: 1.5 V p-p @ 50 kHz, 0.7 V p-p @ 5 Hz  
 Configurable duty cycle from 10 % up to 90 % with minimum amplitude of 5 V p-p

8) For both frequency inputs simultaneously (IN A + IN B)

9) For only one frequency input (IN A or IN B) in the same time

10) Amplitude: 1 ... 80 V, frequency: 0.5 ... 20 Hz

## Electrical output signal

Electrical signal	Measuring range	Full scale	Precision % of rdg ±% FS	Accuracy % of rdg ±% FS	Max. resolution
Voltage DC 1)	0 ... 100 mV 2)	100 mV	0.01 % ±0.003 % FS	0.015 % ±0.003 % FS	0.0001 mV
	0 ... 2 V 3)	2 V	0.01 % ±0.003 % FS	0.015 % ±0.003 % FS	0.000001 V
	0 ... 20 V 3)	20 V	0.015 % ±0.003 % FS	0.02 % ±0.003 % FS	0.00001 V
Current DC 4)	0 ... 20 mA 5)	20 mA	0.02 % ±0.003 % FS	0.025 % ±0.003 % FS	0.0001 mA
Resistance 4)	0 ... 400 Ω	400 Ω	0.008 % ±0.003 % FS	0.01 % ±0.003 % FS	0.001 Ω
	0 ... 10,000 Ω	10,000 Ω	0.008 % ±0.002 % FS	0.01 % ±0.002 % FS	0.01 Ω
Frequency	0.5 ... 20,000 Hz	20,000 Hz	0.1 Hz	0.1 Hz	0.001 Hz
Pulses 6)	1 ... 999,999	999,999	N/A	N/A	1

1) One year specifications with temperature effect: 0.001 % output \* It - tcl for t : -10 °C ≤ t ≤ 19 °C and 23 °C ≤ t ≤ 50 °C and tc = 20 °C  
14 °F ≤ t ≤ 66.2 °F and 73.4 °F ≤ t ≤ 122 °F and tc = 68 °F

2) Output impedance = 10 Ω - Rlmin > 1 kΩ

3) Output impedance < 30 mΩ - Rlmin > 1 kΩ

4) One year specifications with temperature effect: 0.002 % output \* It - tcl for t : -10 °C ≤ t ≤ 19 °C and 23 °C ≤ t ≤ 50 °C and tc = 20 °C  
14 °F ≤ t ≤ 66.2 °F and 73.4 °F ≤ t ≤ 122 °F and tc = 68 °F

5) Output impedance > 100 MΩ - Rlmax < 750 Ω

6) Amplitude: 0.1 ... 15 Vrms, frequency: 0.5 ... 200 Hz

### HART® module:

- For communication with HART® instruments
- Supports a selected set of HART® universal and common practice commands
- Read basic device information and trim the mA output on most HART® enabled transmitters
- No necessity to use DDL specific libraries
- Integrated 250 Ω resistance
- Integrated 24 V voltage supply

### HART® communication:

The Pascal ET offers an optional HART® module with following commands:

- Read unique identifier
- Read current and percentage of range
- Read current and four (predefined) dynamic variables
- Read tag (TAG), descriptor (DD), date
- Read PV sensor information
- Read output information
- Write tag (TAG), descriptor (DD), date
- Enable/disable fixed current mode
- Trim DAC zero
- Trim DAC gain

## Resistance thermometer measurement

- One year specifications
- Temperature effect see "Electrical input signal/Resistance"
- Measure current: < 200  $\mu$ A
- Specification for 4-wire measurements with  $I_{\text{meas.}} < 0.2 \text{ mA}$

Input signals	Measuring range	Precision	Accuracy	Resolution
<b>Pt100 (385) 1)</b>	-200 ... 0 °C (-328 ... +32 °F)	0.05 °C (0.09 °F)	0.06 °C (0.11 °F)	0.01 °C (0.02 °F)
	0 ... 300 °C (32 ... 572 °F)	0.07 °C (0.13 °F)	0.09 °C (0.16 °F)	
	300 ... 850 °C (572 ... 1,562 °F)	0.15 °C (0.27 °F)	0.17 °C (0.31 °F)	
<b>Pt100 (3916) 2)</b>	-200 ... 0 °C (-328 ... +32 °F)	0.05 °C (0.09 °F)	0.06 °C (0.11 °F)	0.01 °C (0.02 °F)
	0 ... 300 °C (32 ... 572 °F)	0.07 °C (0.13 °F)	0.09 °C (0.16 °F)	
	300 ... 850 °C (572 ... 1,562 °F)	0.15 °C (0.27 °F)	0.17 °C (0.31 °F)	
<b>Pt100 (3902) 3)</b>	-200 ... 0 °C (-328 ... +32 °F)	0.05 °C (0.09 °F)	0.06 °C (0.11 °F)	0.01 °C (0.02 °F)
	0 ... 300 °C (32 ... 572 °F)	0.07 °C (0.13 °F)	0.09 °C (0.16 °F)	
	300 ... 850 °C (572 ... 1,562 °F)	0.15 °C (0.27 °F)	0.17 °C (0.31 °F)	
<b>Pt100 (3926) 4)</b>	-200 ... 0 °C (-328 ... +32 °F)	0.05 °C (0.09 °F)	0.06 °C (0.11 °F)	0.01 °C (0.02 °F)
	0 ... 300 °C (32 ... 572 °F)	0.07 °C (0.13 °F)	0.09 °C (0.16 °F)	
	300 ... 850 °C (572 ... 1,562 °F)	0.15 °C (0.27 °F)	0.17 °C (0.31 °F)	
<b>Pt100 (3923) 5)</b>	-200 ... 0 °C (-328 ... +32 °F)	0.05 °C (0.09 °F)	0.06 °C (0.11 °F)	0.01 °C (0.02 °F)
	0 ... 300 °C (32 ... 572 °F)	0.07 °C (0.13 °F)	0.09 °C (0.16 °F)	
	300 ... 850 °C (572 ... 1,562 °F)	0.15 °C (0.27 °F)	0.17 °C (0.31 °F)	
<b>Pt200 (385) 1)</b>	-200 ... 0 °C (-328 ... +32 °F)	0.05 °C (0.09 °F)	0.06 °C (0.11 °F)	0.01 °C (0.02 °F)
	0 ... 300 °C (32 ... 572 °F)	0.09 °C (0.16 °F)	0.1 °C (0.18 °F)	
	300 ... 850 °C (572 ... 1,562 °F)	0.18 °C (0.32 °F)	0.21 °C (0.38 °F)	
<b>Pt500 (385) 1)</b>	-200 ... 0 °C (-328 ... +32 °F)	0.05 °C (0.09 °F)	0.06 °C (0.11 °F)	0.01 °C (0.02 °F)
	0 ... 300 °C (32 ... 572 °F)	0.09 °C (0.16 °F)	0.1 °C (0.18 °F)	
	300 ... 850 °C (572 ... 1,562 °F)	0.18 °C (0.32 °F)	0.21 °C (0.38 °F)	
<b>Pt1000 (385) 1)</b>	-200 ... 0 °C (-328 ... +32 °F)	0.05 °C (0.09 °F)	0.06 °C (0.11 °F)	0.01 °C (0.02 °F)
	0 ... 300 °C (32 ... 572 °F)	0.09 °C (0.16 °F)	0.1 °C (0.18 °F)	
	300 ... 850 °C (572 ... 1,562 °F)	0.18 °C (0.32 °F)	0.21 °C (0.38 °F)	
<b>Pt1000 (3916) 2)</b>	-200 ... 0 °C (-328 ... +32 °F)	0.05 °C (0.09 °F)	0.06 °C (0.11 °F)	0.01 °C (0.02 °F)
	0 ... 300 °C (32 ... 572 °F)	0.09 °C (0.16 °F)	0.1 °C (0.18 °F)	
	300 ... 850 °C (572 ... 1,562 °F)	0.18 °C (0.32 °F)	0.21 °C (0.38 °F)	
<b>Cu10 (42) 6)</b>	-70 ... 0 °C (-94 ... +32 °F)	0.23 °C (0.41 °F)	0.28 °C (0.5 °F)	0.1 °C (0.18 °F)
	0 ... 40 °C (32 ... 104 °F)	0.24 °C (0.43 °F)	0.29 °C (0.52 °F)	
	40 ... 150 °C (104 ... 302 °F)	0.27 °C (0.49 °F)	0.3 °C (0.54 °F)	
<b>Cu100 7)</b>	-180 ... 0 °C (-295 ... +32 °F)	0.06 °C (0.11 °F)	0.07 °C (0.13 °F)	0.01 °C (0.02 °F)
	0 ... 80 °C (32 ... 176 °F)	0.07 °C (0.13 °F)	0.08 °C (0.14 °F)	
	80 ... 150 °C (176 ... 302 °F)	0.08 °C (0.14 °F)	0.09 °C (0.16 °F)	
<b>Ni100 (617) 8)</b>	-60 ... 0 °C (-76 ... 32 °F)	0.04 °C (0.07 °F)	0.05 °C (0.09 °F)	0.01 °C (0.02 °F)
	0 ... 100 °C (32 ... 212 °F)	0.05 °C (0.09 °F)	0.06 °C (0.11 °F)	
	100 ... 180 °C (212 ... 356 °F)			
<b>Ni120 (672) 9)</b>	0 ... 100 °C (32 ... 212 °F)	0.04 °C (0.07 °F)	0.05 °C (0.09 °F)	0.01 °C (0.02 °F)
	100 ... 150 °C (212 ... 302 °F)	0.05 °C (0.09 °F)		

1) IEC 751 ( $\alpha = 0.00385 \text{ }^{\circ}\text{C}^{-1}$ )

2) JIS C1604 ( $\alpha = 0.003916 \text{ }^{\circ}\text{C}^{-1}$ )

3) U.S. Standard ( $\alpha = 0.003902 \text{ }^{\circ}\text{C}^{-1}$ )

4) Old U.S. Standard ( $\alpha = 0.003926 \text{ }^{\circ}\text{C}^{-1}$ )

5) SAMA ( $\alpha = 0.003923 \text{ }^{\circ}\text{C}^{-1}$ )

6)  $\alpha = 0.0042 \text{ }^{\circ}\text{C}^{-1}$

7)  $\alpha = 0.0042 \text{ }^{\circ}\text{C}^{-1}$

8) DIN 43760 ( $\alpha = 0.00617 \text{ }^{\circ}\text{C}^{-1}$ )

9)  $\alpha = 0.00672 \text{ }^{\circ}\text{C}^{-1}$

## Resistance thermometer simulation

- One year specifications
- Temperature effect see "Electrical output signal/Resistance"

Output signals	Measuring range	Precision	Accuracy	Resolution
<b>Pt100 (385) 1)</b>	-200 ... 0 °C (-328 ... +32 °F)	0.05 °C (0.09 °F)	0.06 °C (0.11 °F)	0.01 °C (0.02 °F)
	0 ... 300 °C (32 ... 572 °F)	0.07 °C (0.13 °F)	0.09 °C (0.16 °F)	
	300 ... 850 °C (572 ... 1,562 °F)	0.15 °C (0.27 °F)	0.17 °C (0.31 °F)	
<b>Pt100 (3916) 2)</b>	-200 ... 0 °C (-328 ... +32 °F)	0.05 °C (0.09 °F)	0.06 °C (0.11 °F)	0.01 °C (0.02 °F)
	0 ... 300 °C (32 ... 572 °F)	0.07 °C (0.13 °F)	0.09 °C (0.16 °F)	
	300 ... 850 °C (572 ... 1,562 °F)	0.15 °C (0.27 °F)	0.17 °C (0.31 °F)	
<b>Pt100 (3902) 3)</b>	-200 ... 0 °C (-328 ... +32 °F)	0.05 °C (0.09 °F)	0.06 °C (0.11 °F)	0.01 °C (0.02 °F)
	0 ... 300 °C (32 ... 572 °F)	0.07 °C (0.13 °F)	0.09 °C (0.16 °F)	
	300 ... 850 °C (572 ... 1,562 °F)	0.15 °C (0.27 °F)	0.17 °C (0.31 °F)	
<b>Pt100 (3926) 4)</b>	-200 ... 0 °C (-328 ... +32 °F)	0.05 °C (0.09 °F)	0.06 °C (0.11 °F)	0.01 °C (0.02 °F)
	0 ... 300 °C (32 ... 572 °F)	0.07 °C (0.13 °F)	0.09 °C (0.16 °F)	
	300 ... 850 °C (572 ... 1,562 °F)	0.15 °C (0.27 °F)	0.17 °C (0.31 °F)	
<b>Pt100 (3923) 5)</b>	-200 ... 0 °C (-328 ... +32 °F)	0.05 °C (0.09 °F)	0.06 °C (0.11 °F)	0.01 °C (0.02 °F)
	0 ... 300 °C (32 ... 572 °F)	0.07 °C (0.13 °F)	0.09 °C (0.16 °F)	
	300 ... 850 °C (572 ... 1,562 °F)	0.15 °C (0.27 °F)	0.17 °C (0.31 °F)	
<b>Pt200 (385) 1)</b>	-200 ... 0 °C (-328 ... +32 °F)	0.05 °C (0.09 °F)	0.06 °C (0.11 °F)	0.01 °C (0.02 °F)
	0 ... 300 °C (32 ... 572 °F)	0.09 °C (0.16 °F)	0.1 °C (0.18 °F)	
	300 ... 850 °C (572 ... 1,562 °F)	0.18 °C (0.32 °F)	0.21 °C (0.38 °F)	
<b>Pt500 (385) 1)</b>	-200 ... 0 °C (-328 ... +32 °F)	0.05 °C (0.09 °F)	0.06 °C (0.11 °F)	0.01 °C (0.02 °F)
	0 ... 300 °C (32 ... 572 °F)	0.09 °C (0.16 °F)	0.1 °C (0.18 °F)	
	300 ... 850 °C (572 ... 1,562 °F)	0.18 °C (0.32 °F)	0.21 °C (0.38 °F)	
<b>Pt1000 (385) 1)</b>	-200 ... 0 °C (-328 ... +32 °F)	0.05 °C (0.09 °F)	0.06 °C (0.11 °F)	0.01 °C (0.02 °F)
	0 ... 300 °C (32 ... 572 °F)	0.09 °C (0.16 °F)	0.1 °C (0.18 °F)	
	300 ... 850 °C (572 ... 1,562 °F)	0.18 °C (0.32 °F)	0.21 °C (0.38 °F)	
<b>Pt1000 (3916) 2)</b>	-200 ... 0 °C (-328 ... +32 °F)	0.05 °C (0.09 °F)	0.06 °C (0.11 °F)	0.01 °C (0.02 °F)
	0 ... 300 °C (32 ... 572 °F)	0.09 °C (0.16 °F)	0.1 °C (0.18 °F)	
	300 ... 850 °C (572 ... 1,562 °F)	0.18 °C (0.32 °F)	0.21 °C (0.38 °F)	
<b>Cu10 (42) 6)</b>	-70 ... 0 °C (-94 ... +32 °F)	0.23 °C (0.41 °F)	0.28 °C (0.5 °F)	0.1 °C (0.18 °F)
	0 ... 40 °C (32 ... 104 °F)	0.24 °C (0.43 °F)	0.29 °C (0.52 °F)	
	40 ... 150 °C (104 ... 302 °F)	0.27 °C (0.49 °F)	0.3 °C (0.54 °F)	
<b>Cu100 7)</b>	-180 ... 0 °C (-295 ... +32 °F)	0.06 °C (0.11 °F)	0.07 °C (0.13 °F)	0.01 °C (0.02 °F)
	0 ... 80 °C (32 ... 176 °F)	0.07 °C (0.13 °F)	0.08 °C (0.14 °F)	
	80 ... 150 °C (176 ... 302 °F)	0.08 °C (0.14 °F)	0.09 °C (0.16 °F)	
<b>Ni100 (617) 8)</b>	-60 ... 0 °C (-76 ... 32 °F)	0.04 °C (0.07 °F)	0.05 °C (0.09 °F)	0.01 °C (0.02 °F)
	0 ... 100 °C (32 ... 212 °F)	0.05 °C (0.09 °F)	0.06 °C (0.11 °F)	
	100 ... 180 °C (212 ... 356 °F)			
<b>Ni120 (672) 9)</b>	0 ... 100 °C (32 ... 212 °F)	0.04 °C (0.07 °F)	0.05 °C (0.09 °F)	0.01 °C (0.02 °F)
	100 ... 150 °C (212 ... 302 °F)	0.05 °C (0.09 °F)		

1) IEC 751 ( $\alpha = 0.00385 \text{ } ^\circ\text{C}^{-1}$ )

2) JIS C1604 ( $\alpha = 0.003916 \text{ } ^\circ\text{C}^{-1}$ )

3) U.S. Standard ( $\alpha = 0.003902 \text{ } ^\circ\text{C}^{-1}$ )

4) Old U.S. Standard ( $\alpha = 0.003926 \text{ } ^\circ\text{C}^{-1}$ )

5) SAMA ( $\alpha = 0.003923 \text{ } ^\circ\text{C}^{-1}$ )

6)  $\alpha = 0.0042 \text{ } ^\circ\text{C}^{-1}$

7)  $\alpha = 0.0042 \text{ } ^\circ\text{C}^{-1}$

8) DIN 43760 ( $\alpha = 0.00617 \text{ } ^\circ\text{C}^{-1}$ )

9)  $\alpha = 0.00672 \text{ } ^\circ\text{C}^{-1}$

## Thermocouple measurement

Input signals	Measuring range	Linear error	Resolution	Precision % of rdg ±% FS	Accuracy % of rdg ±% FS
Type J 1)	-190 ... 0 °C (-310 ... +32 °F)	0.05 °C (0.09 °F)	0.01 °C (0.02 °F)	0.008 % ±0.002 % FS	0.01 % ±0.003 % FS
	0 ... 1,200 °C (32 ... 2,192 °F)	0.04 °C (0.07 °F)			
Type K 1)	-160 ... 0 °C (-256 ... +32 °F)	0.06 °C (0.11 °F)	0.01 °C (0.02 °F)	0.008 % ±0.002 % FS	0.01 % ±0.003 % FS
	0 ... 1,260 °C (32 ... 2,300 °F)	0.04 °C (0.07 °F)			
Type T 1)	-130 ... 0 °C (-202 ... +32 °F)	0.05 °C (0.09 °F)	0.01 °C (0.02 °F)	0.01 % ±0.003 % FS	0.01 % ±0.003 % FS
	0 ... 400 °C (32 ... 752 °F)	0.04 °C (0.07 °F)			
Type F 1)	0 ... 400 °C (32 ... 752 °F)	0.05 °C (0.09 °F)	0.1 °C (0.18 °F)	0.008 % ±0.002 % FS	0.01 % ±0.003 % FS
Type R	160 ... 1,760 °C (320 ... 3,200 °F)	0.04 °C (0.07 °F)	0.1 °C (0.18 °F)	0.008 % ±0.002 % FS	0.01 % ±0.003 % FS
Type S	170 ... 1,760 °C (338 ... 3,200 °F)	0.04 °C (0.07 °F)	0.1 °C (0.18 °F)	0.008 % ±0.002 % FS	0.01 % ±0.003 % FS
Type B 1)	920 ... 1,820 °C (1,688 ... 3,308 °F)	0.1 °C (0.18 °F)	0.1 °C (0.18 °F)	0.008 % ±0.002 % FS	0.01 % ±0.003 % FS
Type U 1)	-160 ... 0 °C (-256 ... +32 °F)	0.04 °C (0.07 °F)	0.01 °C (0.02 °F)	0.008 % ±0.002 % FS	0.01 % ±0.003 % FS
	0 ... 400 °C (32 ... 752 °F)				
Type L 1)	-200 ... 0 °C (-328 ... +32 °F)	0.03 °C (0.05 °F)	0.01 °C (0.02 °F)	0.008 % ±0.002 % FS	0.01 % ±0.003 % FS
	0 ... 760 °C (32 ... 1,400 °F)	0.04 °C (0.07 °F)			
Type N	0 ... 1,300 °C (32 ... 2,372 °F)	0.04 °C (0.07 °F)	0.01 °C (0.02 °F)	0.008 % ±0.002 % FS	0.01 % ±0.003 % FS
Type E	-200 ... 0 °C (-328 ... +32 °F)	0.03 °C (0.05 °F)	0.01 °C (0.02 °F)	0.008 % ±0.002 % FS	0.01 % ±0.003 % FS
	0 ... 1,000 °C (32 ... 1,832 °F)	0.04 °C (0.07 °F)			
Type C 1)	0 ... 2,000 °C (32 ... 3,632 °F)	0.05 °C (0.09 °F)	0.1 °C (0.18 °F)	0.008 % ±0.002 % FS	0.01 % ±0.003 % FS

- 1) Precision and accuracy of the e.m.f. values  
 For measurements with internal cold junction compensation: cold junction error = 0.15 °C  
 Maximum input voltage: DC ±100 V  
 Input Impedance: > 100 MΩ  
 Temperature effect: 0.001 % of reading \* |t - t<sub>c</sub>| for t: -10 °C ≤ t ≤ 19 °C and 23 °C ≤ t ≤ 50 °C and t<sub>c</sub> = 20 °C  
 14 °F ≤ t ≤ 66.2 °F and 73.4 °F ≤ t ≤ 122 °F and t<sub>c</sub> = 68 °F
- One year specifications

## Thermocouple simulation

Output signals	Measuring range	Linear error	Resolution	Precision % of rdg ±% FS	Accuracy % of rdg ±% FS
Type J 1)	-190 ... 0 °C (-310 ... +32 °F)	0.05 °C (0.09 °F)	0.01 °C (0.02 °F)	0.01 % ±0.003 % FS	0.015 % ±0.003 % FS
	0 ... 1,200 °C (32 ... 2,192 °F)	0.04 °C (0.07 °F)			
Type K 1)	-160 ... 0 °C (-256 ... +32 °F)	0.06 °C (0.11 °F)	0.01 °C (0.02 °F)	0.01 % ±0.003 % FS	0.015 % ±0.003 % FS
	0 ... 1,260 °C (32 ... 2,300 °F)	0.04 °C (0.07 °F)			
Type T 1)	-130 ... 0 °C (-202 ... +32 °F)	0.05 °C (0.09 °F)	0.01 °C (0.02 °F)	0.01 % ±0.003 % FS	0.015 % ±0.003 % FS
	0 ... 400 °C (32 ... 752 °F)	0.04 °C (0.07 °F)			
Type F 1)	0 ... 400 °C (32 ... 752 °F)	0.05 °C (0.09 °F)	0.1 °C (0.18 °F)	0.01 % ±0.003 % FS	0.015 % ±0.003 % FS
Type R	160 ... 1,760 °C (320 ... 3,200 °F)	0.04 °C (0.07 °F)	0.1 °C (0.18 °F)	0.01 % ±0.003 % FS	0.015 % ±0.003 % FS
Type S	170 ... 1,760 °C (338 ... 3,200 °F)	0.04 °C (0.07 °F)	0.1 °C (0.18 °F)	0.01 % ±0.003 % FS	0.015 % ±0.003 % FS
Type B 1)	920 ... 1,820 °C (1,688 ... 3,308 °F)	0.1 °C (0.18 °F)	0.1 °C (0.18 °F)	0.01 % ±0.003 % FS	0.015 % ±0.003 % FS
Type U 1)	-160 ... 0 °C (-256 ... +32 °F)	0.04 °C (0.07 °F)	0.01 °C (0.02 °F)	0.01 % ±0.003 % FS	0.015 % ±0.003 % FS
	0 ... 400 °C (32 ... 752 °F)				
Type L 1)	-200 ... 0 °C (-328 ... +32 °F)	0.03 °C (0.05 °F)	0.01 °C (0.02 °F)	0.01 % ±0.003 % FS	0.015 % ±0.003 % FS
	0 ... 760 °C (32 ... 1,400 °F)	0.04 °C (0.07 °F)			
Type N	0 ... 1,300 °C (32 ... 2,372 °F)	0.04 °C (0.07 °F)	0.01 °C (0.02 °F)	0.01 % ±0.003 % FS	0.015 % ±0.003 % FS
Type E	-200 ... 0 °C (-328 ... +32 °F)	0.03 °C (0.05 °F)	0.01 °C (0.02 °F)	0.01 % ±0.003 % FS	0.015 % ±0.003 % FS
	0 ... 1,000 °C (32 ... 1,832 °F)	0.04 °C (0.07 °F)			
Type C 1)	0 ... 2,000 °C (32 ... 3,632 °F)	0.05 °C (0.09 °F)	0.1 °C (0.18 °F)	0.01 % ±0.003 % FS	0.015 % ±0.003 % FS

- 1) Precision and accuracy of the e.m.f. generation  
 For temperature simulation with internal cold junction compensation: cold junction error = 0.15 °C

## Environmental parameters module

Parameter	Measuring range	Precision	Accuracy	Max. resolution
Temperature	-10 ... +50 °C (14 ... 122 °F)	2.7 °C (4.86 °F)	3.0 °C (5.4 °F)	0.1 °C (0.18 °F)
Barometric pressure	650 ... 1,150 mbar (9.43 ... 16.68 psi)	4 % FS	5 % FS	1 mbar (0.015 psi)
Relative humidity	10 ... 90 % r. h.	12 %	15 %	1 %



## Dimensions in mm (in)

### Instrument models Pascal ET and Pascal ET/IS

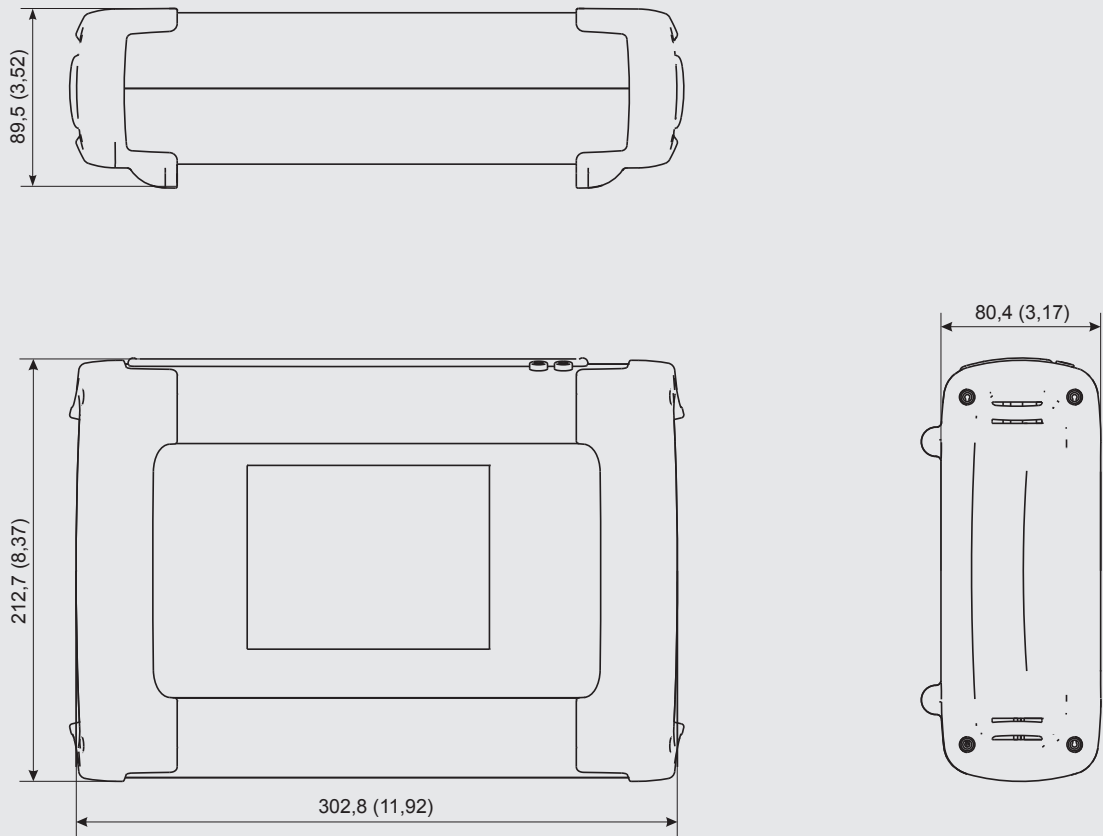

### Front panel of model Pascal ET/IS

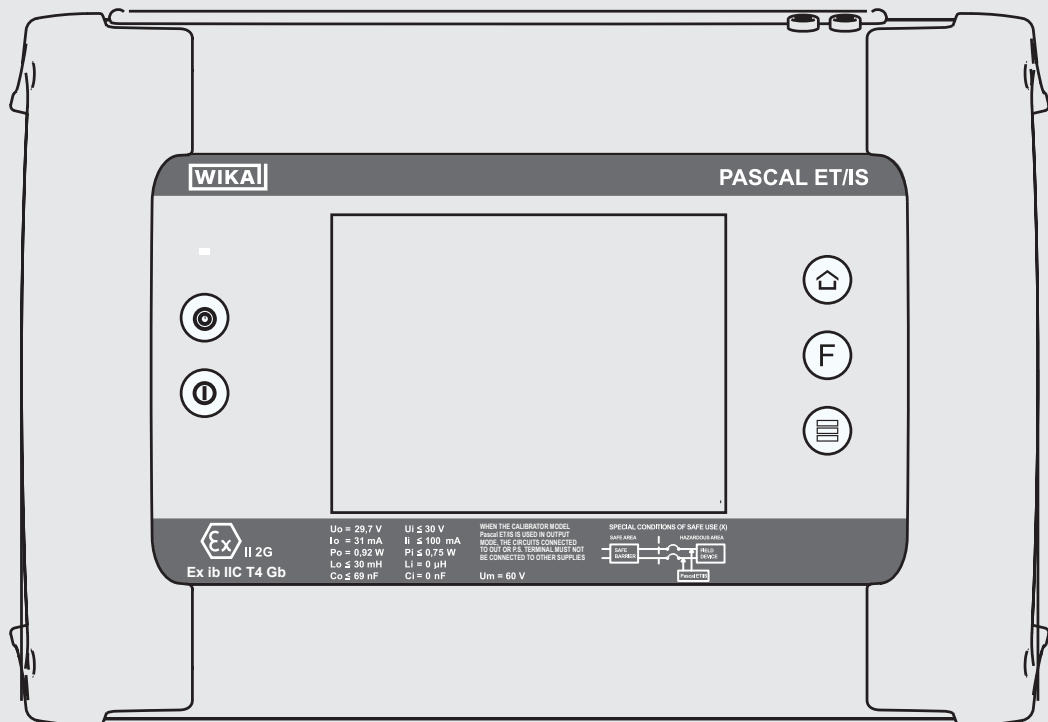

## Software

### Pascal report software

The Pascal report software allows the configuration in A4 format of the calibration reports and/or certificates according to users standards.

Importing stored reports from the instrument by RS-232 serial interface/USB (with adapter) makes Pascal report the safer software system to support any calibration procedure according to ISO 9000 standards.

### PasLog software

The PasLog software allows the download and the management of the logging data from the instrument to the PC. Data can be displayed and print out in a tabular format as well as in a graphical one. The user interface can be customised.

## Scope of delivery

- Portable multifunction calibrator model Pascal ET or Pascal ET/IS
- Operating instructions
- AC adapter
- Pascal report software
- RS-232 interface cable
- RS-232 to USB adapter
- Test-cable set; order no. 241076
- 3.1 calibration certificate per DIN EN 10204

## Option

- ATEX approval:  
II 2G Ex ib IIC T4 Gb - T<sub>amb</sub>: -10 ... +50 °C
- IECEx approval:  
Ex ib IIC T4 Gb - T<sub>amb</sub>: -10 ... +50 °C
- ACCREDIA calibration certificate
- Environmental parameters module
- Hydraulic test pumps
- Pneumatic test pumps
- PasLog software

## Ordering information

Model / Explosion Proof / Input module electrical - temperature / Calibration electrical input module / Output module electrical - temperature / Calibration electrical output module / Environmental parameters module / Software / Language / Additional order information

© 10/2012 WIKA Alexander Wiegand SE & Co. KG, all rights reserved.  
The specifications given in this document represent the state of engineering at the time of publishing.  
We reserve the right to make modifications to the specifications and materials.

