

# Hand-Held Lubrication

## PowerLuber® Grease Guns



### Professional Two-Speed 14.4-Volt Cordless Grease Gun

Lincoln's new, heavy-duty 14.4-Volt PowerLuber gives you the power to lubricate just about anything, anytime, anywhere. Two-speed switch for high-pressure or high-volume delivery. Cycle indicator pin to monitor grease output. "Smart" charging system delivers reliable power. All the features you need, including comfortable grip and balanced design; hook for shoulder strap; built-in hose and coupler holder; and a slim, compact carrying case.



#### PowerLuber 14.4 Features

- Powerful 14.4-volt high-torque motor—7,500 psi working output pressure, 10 oz./min. grease output at 1,000 psi
- Machined and hardened piston
- Slotted powerhead accepts shoulder strap (strap sold separately)
- Threaded opening (1/8" NPT) for filler nipple (not included)
- Accessible check valve
- Plated steel barrel with exclusive flip-over follower
- One-hour "smart" charge
- High-capacity NiCad 14.4-volt battery
- 30" high-pressure hose with spring guard and coupler

#### Model 1442

Includes grease gun, charger, battery and carrying case.

#### Model 1444

Includes grease gun, charger, batteries (2) and carrying case.

#### Model 1242

The standard PowerLuber 1242 comes outfitted with a heavy-duty carrying case. Comes complete with:

- 110-volt fast charger (model 1210)
- 12-volt NiCad rechargeable battery (model 1201)
- 30" flex hose with spring guard (model 1230)
- Custom carrying case (model 1202) designed to hold two rechargeable batteries and two grease cartridges (*grease not included*)



#### Model 1244

Top of the line. Includes second 12-volt rechargeable battery 1201 for uninterrupted lube application.

#### Model 1240

Economy packed without carrying case. Includes one 12-volt rechargeable battery 1201 and battery charger 1210.

#### Model 1200

PowerLuber and battery only.

### PowerLuber Accessories

#### Batteries

14.4-volt NiCad rechargeable battery (**Model 1401**) comes standard with the PowerLuber Model 1444. Model 1201 battery easily snaps in for use with the PowerLuber 1242 Grease Gun and Model 1203 for 7.2V PowerLuber and Model 1227 for 3.6V MiniLuber.

#### Whip Hoses

Attach to PowerLuber with 7/16" UNEF fitting, 1/8" NPT(m) outlet. Working pressure 7500 psi (517 bar). **Model 1218** (18"), **1224** (24"), **1230** (30") and **1236** (36").

#### Chargers

#### Model 1410

"Smart" charger recharges batteries in less than one hour and recognizes battery condition when not in use. For use with Model 1442 and 1444. **Model 1210**—110-volt one-hour fast charger for use with battery pack 1201. 6 ft. cord; UL/ULC listed. Also Model 1211 for 7.2-volt PowerLuber.

#### Model 1215

12-volt to 12-volt DC field charger for use with battery pack 1201 (plugs into cigarette lighter). **Model 1215A** allows use of both 12-volt and 24-volt DC input.

#### Model 1415A

14.4-volt DC field charger.

#### Model 1414

Shoulder strap for hands-free movement from job to job.



# Hand-Held Lubrication

## Heavy-Duty & Air-Operated Grease Guns



Lincoln heavy-duty grease guns incorporate the same unique features as Model 1142 on page 72.

### Air-Operated

#### Model 1163 PowerLuber®

1163



Fully automatic grease gun. New motor design provides outstanding durability and excellent grease flow.

- New purge valve design eliminates trapped air
- Full automatic operation—cycles continuously when trigger is pulled
- Low operational noise
- CE certified, patent pending
- 18" high-pressure flex hose (Model 1218)
- 40:1 air motor capable of 6000 psi. Air operating range 40-150 psi
- Three-way loading with optional 91108 filler nipple
- 6000 psi maximum pressure; outlet opening 7/16" UNEF

### Dual Pressure

#### Model 1013 and 1145

1013



1145



- High or low pressure for light- or heavy-duty greasing action
- Full pressure on short strokes for heavy greasing in tight places; develops full pressure with just 1/4" stroke
- Extension swivels 360° for hard-to-reach fittings.
- Plated barrel, head and handle
- Handy three-way loading: cartridge, filler pump or bulk
- Grease resistant rubber handle grip for positive pumping action

### Precision High-Pressure and Volume

#### Model 1035 & 1037

1035



- Exclusive toggle mechanism design uses compound leverage for high-pressure pumping with little effort
- Rust resistant plated gun barrel and handle, black enamel head.
- Equipped with filler nipple for fast refill from Lincoln filler pump
- 21 oz. bulk capacity for heavy-duty greasing applications

#### Load Pin in Rear Position for High-Output Delivery

With handle in REAR (lo) shift position, grease is delivered at low pressure (maximum 6000 psi) with strokes from 1/4" to 12". Output 1 ounce per 18 full strokes.

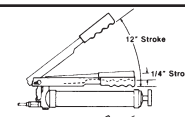

#### Load Pin in Front Position for High-Pressure Delivery

With handle in FRONT (hi) shift position, grease is delivered at high pressure (maximum 7000 psi) with strokes from 1/4" to 9". Output 1 ounce per 33 full strokes.

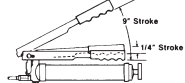

### Dual-Pressure

Model	Lube Capacity	Extension	Length	Max. Pressure
1013	16oz. Bulk/14.5oz. Cartridge	6" & hydraulic coupler	22 7/8"	7000/6000 psi
1145	21oz. Bulk/14.5oz. Cartridge	5853 6" & hydraulic coupler	25 1/4"	7000/6000 psi

Specifications: Output at **low pressure** 1oz. per 18 strokes; at **high pressure** 1 oz. per 33 strokes using No. 1 cup grease at 70°F. Barrel diameter 2 1/4".

### High-Pressure

Model	Lube Capacity	Extension	Length	Max. Pressure
1035	21oz. bulk/14.5oz. cartridge	5834 6" & heavy-duty coupler	27 1/4"	7000 psi

Specifications: Lubricant output 1 oz. per 25 strokes using No. 1 cup grease at 70°F. Barrel diameter 2 1/4".

### Volume

Model	Lube Capacity	Extension	Length	Max. Pressure
1037	21oz. bulk/14.5oz. cartridge	5834 6" & hydraulic coupler	27 1/4"	3000 psi

Specifications: Lubricant output 1 oz. per 9 strokes using No. 1 cup grease at 70°F. Barrel diameter 2 1/4"

# Hand-Held Lubrication

## Grease Guns



### **Lincoln . . . the brand the pros demand for quality lubrication tools**

For over 90 years the industry has recognized Lincoln as the leader in professional lubrication tools.

Professional automotive, agricultural and industrial mechanics depend on Lincoln tools for their livelihood. Lincoln tools offer a lifetime of performance and are backed by the most comprehensive warranty in the industry.

### **Lincoln hand-held grease guns offer:**

- Rugged cast pump head for strength and durability.
- Jam-proof toggle mechanism prevents binding or accidental bending of plunger.
- Exclusive "Flip-Over" follower allows a superior seal for either cartridge or bulk loading applications. Tough, resilient and impervious to lubricant.
- Extra-heavy follower spring insures positive priming and uninterrupted pumping action.
- Accessible check valve allows easy cleaning without gun disassembly.
- Precision fit and hardened plunger prevents lubricant bypass, resists scoring for longer life.
- Follower rod locks into follower to force prime.

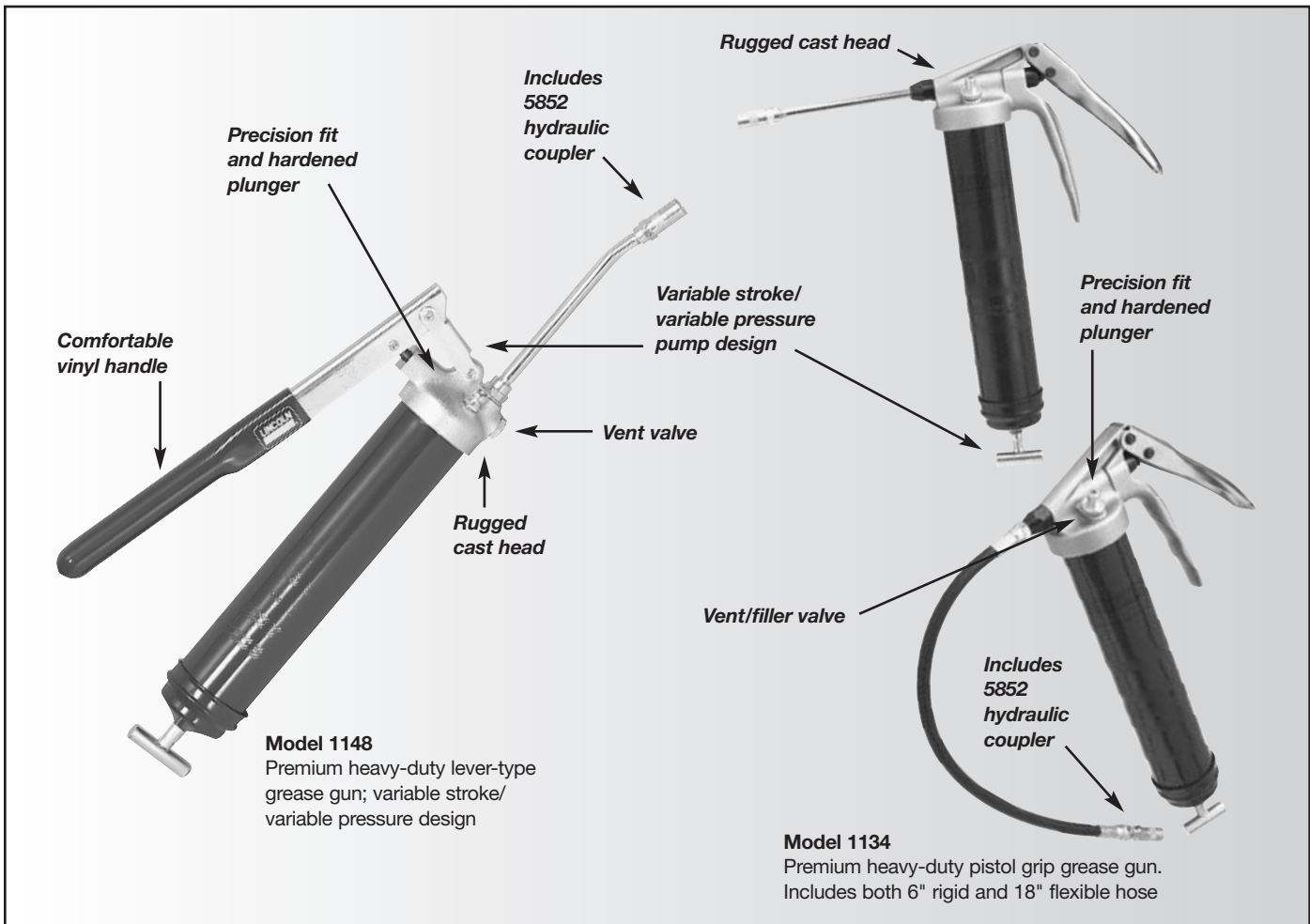

# Hand-Held Lubrication

## Lever & Pistol Grip Grease Guns



### Heavy-Duty Lever Type

#### Model 1142

First choice of professionals everywhere.

#### Model 1148

Same as 1142, with handle grip and vent valve for purging air from gun. Two-way filling, suction and cartridge. Variable stroke/variable pressure: short stroke–high pressure; long stroke–high volume.

#### Model 1147

Same as 1142 with 18" whip hose and coupler; flip-over follower set for cartridge use.

#### Model 1151

Same as 1142 but holds 21 ounces bulk; flip-over follower set for bulk loading.



### Heavy-Duty Pistol Grip Type

#### Model 1132

Fast, one-hand operation with similar features and benefits of Lincoln lever type grease guns. Includes 5" extension with coupler.

#### Model 1133

Same as 1132 with 18" whip hose and coupler.

#### Model 1134

Extra-heavy-duty pistol grip grease gun. Cast head design. Jam proof handle return mechanism. Develops up to 7500 psi. Includes both 18" whip hose with coupler and 6" rigid tube. Variable stroke/pressure design.



### Grease Guns Lever Type

Model	Lube Capacity	Extension	Length
1142*	16oz. Bulk/14.5oz. Cartridge	5853 6" & 5852 coupler	21 <sup>3</sup> / <sub>4</sub> "
1148*	16oz. Bulk/14.5oz. Cartridge	5853 6" & 5852 coupler	21 <sup>3</sup> / <sub>4</sub> "
1147*	16oz. Bulk/14.5oz. Cartridge	71518 18" Hose & 5852 coupler	21 <sup>3</sup> / <sub>4</sub> "
1151**	21oz. Bulk/14.5oz. Cartridge	5853 6" & 5852 coupler	24 <sup>1</sup> / <sub>2</sub> "

Specifications: Output 1oz. per 33 strokes using No. 1 grease at 70°F. Barrel diameter 2<sup>1</sup>/<sub>4</sub>"

\*Follower set for cartridge use. \*\*Follower set for bulk loading.

### Grease Guns Pistol Grip

Model	Lube Capacity	Extension	Length
1133*	16oz. Bulk/14.5oz. Cartridge	71518 18" Flex Hose & 5852 coupler	15 <sup>1</sup> / <sub>2</sub> "
1132*	16oz. Bulk/14.5oz. Cartridge	6" Straight Pipe & 5852 coupler	15 <sup>1</sup> / <sub>2</sub> "
1134*	16oz. Bulk/14.5oz. Cartridge	18" Flex Hose, 6" Straight Pipe & Coupler	15 <sup>1</sup> / <sub>2</sub> "

Specifications: Output 1oz. per 33 strokes using No. 1 grease at 70°F. Barrel diameter 2<sup>1</sup>/<sub>4</sub>"

\*Follower set for cartridge use.



82760



91108



5852

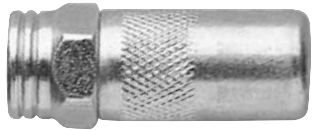

Hydraulic Coupler Displays

### Model 91108 Filler Nipple

Enables hand guns to be loaded using filler pump method. Includes ball check; 1/8" NPT(m).

### Model 82760 Grease Gun Holder

Can be mounted to almost any surface. Holds grease guns and suction guns with 2 1/4" OD barrel. Holds guns until ready to use.

### Hydraulic Couplers

#### Model 5852

- 6000 psi maximum operating pressure.
- For all hydraulic type grease fittings.
- Small outside diameter permits easy contact with recessed fittings.
- Replaceable hardened steel jaws.
- Built-in ball check prevents leak and lubricant backup.
- Inlet 1/8" NPT(f).

### Hydraulic Coupler Displays

#### Model 5852

One hydraulic coupler in a resealable clamshell.

#### Model 5852-2

Two hydraulic couplers in the same clamshell as the 5852.

#### Model 5852-5

Contains five couplers; reduces cost per unit.

#### Model 5852-54

Contains 54 couplers in a displayable box; best value.

### Model 5845 Heavy-Duty

- 7500 psi maximum operating pressure.
- Same as 5852 except 1/8" outside diameter.

### Model 5848 Adapter

- 7000 psi maximum operating pressure.
- Built-in swivel allows full 360° circle.
- Locks in any one of eight 45° positions.
- Adjustable coupler section permits contact with fittings in reverse positions.
- Angle body has 1/8" NPT(f) inlet permits addition of pipe extension when required.

### Special Access Coupler

#### Model 5883 90° Grease Coupler

- Provides access to difficult to reach fittings.
- Allows for easy lubrication in tight areas.

5845

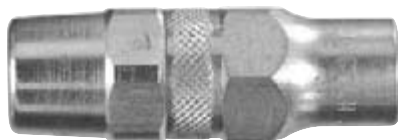

5848

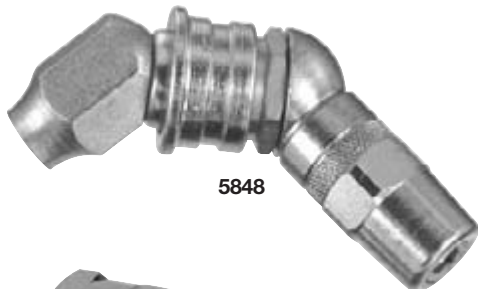

5883



### WARNING

**MATERIAL USE:** Lincoln swivels are to be used only to transport grease, oil and other lubricants and are designed only for these non-abrasive and non-corrosive purposes. Do not use with abrasive and corrosive materials such as sound-deadening materials which may contain limestone and mica particles. Transport of such materials causes rapid premature wear to critical swivel components and can cause failure of swivel. Failure could expose the user to severe bodily injury, permanent disfigurement or death.

**INSTALLATION & SERVICE:** Tighten all fluid connections securely before using swivel. Never exceed 7500 psi maximum operating pressure. Never alter or modify any part of the swivel. Never attempt to repair or disassemble the swivel while the system is pressurized. Never stop or deflect leaks with hand or body.

**MEDICAL ATTENTION:** Get medical attention immediately if exposed to high-pressure fluids. Tell the attending physician what was injected.



### Button-Head Couplers & Adapters

#### Model 80933

4000 psi maximum operating pressure. For pull-on, push-on or hook-on service. Use with large 7/8" diameter button-head fittings. 7/16"-27 (f) thread.

#### Model 81458

Same as 80933 except for 5/8" diameter button-head fittings.

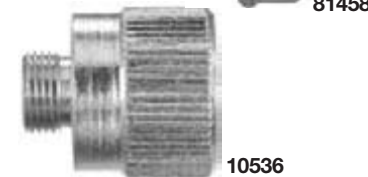

#### Model 10536

5000 psi maximum operating pressure. For adapting standard or large button-head couplers to hose with 1/8" NPT connections. 1/8" NPT(f) x 7/16"-27 (m) thread. Use gasket 31138, not included.



5834



5853



62028



5859



5855

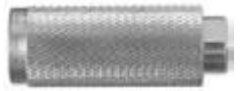

81980



5849



5803



82784



83278

5884



58000

#### Model 10536

4500 psi maximum operating pressure. For adapting standard or large button-head couplers to hose with 3/8" NPT connections. 3/8" NPT(f) x 7/16"-27 (m) thread. Use gasket 31138, not included.

### Coupler Extensions

#### Model 5834

7500 psi maximum operating pressure. Includes 5845 coupler and 62028 6" extension tube. 1/8" NPT(m) connection.

#### Model 5853

6000 psi maximum operating pressure. Includes 5852 hydraulic coupler and 62028 6" extension tube. 1/8" NPT(m) connection.

### Rigid Extensions

#### Model 62028

6" length. Tough, heavy-wall seamless steel tubing. 1/8" NPT(m) at each end.

#### Model 62061

Same as 62028 except 12" length.

#### Model 62117

Same as 62028 except 18" length.

#### Model 5884

Contains the 5883 90° grease coupler plus a quick-connect coupler for fast access to hard-to-reach lube points.

### Extensions Adapters

#### Model 5859 Angle

- 90° angle solves problem of contacting so-called "inaccessible" grease fittings.
- Design eliminates need to remove from "deep dish" wheels for lubrication of the tie rod ends and ball joints.
- Use to service cars, truck, machines and farm equipment.

#### Model 5855 Recessed

Straight extension. Use to lubricate recessed fittings where obstructions will not permit use of hydraulic coupler. Includes extension nozzle and locking sleeve.

#### Model 81980 Locking Sleeve

For adapting any 1/8" NPT(m) extension nozzle to a hydraulic coupler.

#### Model 5849 360 Degree

7500 psi maximum operating pressure. Includes 5848 360° coupler for full swivel, 2" steel extension tube and locking sleeve.

### Needle Nozzles

#### Model 5803

Allows operator to contact flush type or hard-to-reach hydraulic type fittings.

#### Model 5806

Same as 5803 except 6" length.

#### Model 82784

Same as 5803 except with extension and locking sleeve.

#### Model 83278

Use to lubricate U-joints and spindles. Attaches to hydraulic coupler of control valve or grease gun. Includes rubber tip.

### Extension Kit

#### Model 58000

Heavy-duty lube accessory kit contains quick-connect versions of seven of Lincoln's most popular lube accessories. Use with all standard grease guns and dispensing devices.

### WARNING

Never point needle nozzles, adapters or coupler at any part of the body or another person.

# Hand-Held Lubrication

## Grease Hose Extensions

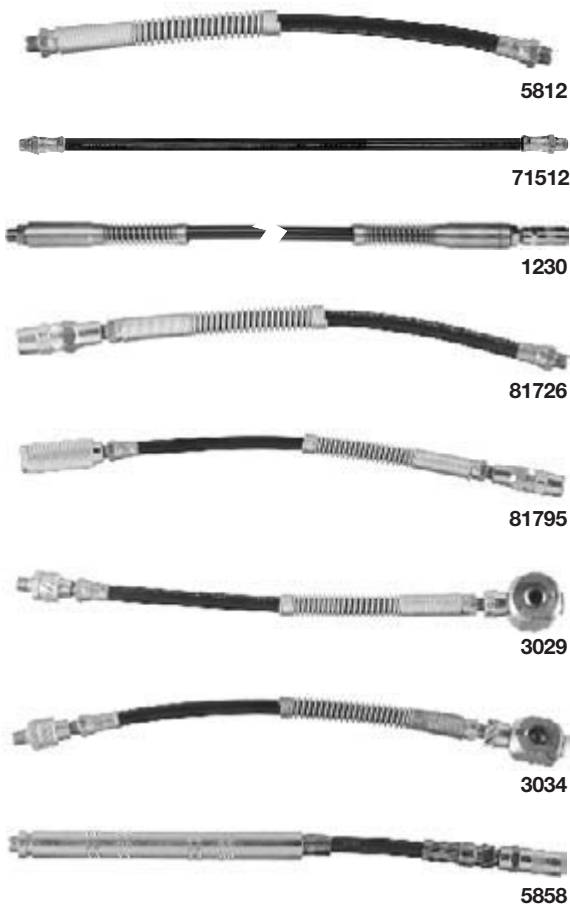

### Extensions for Manually- or Air-Operated Grease Guns

Maximum working pressure 4500 psi. Strategically placed coil spring provides non-slip, push-pull grip and prevents accidental "kinking" which could cause hose ruptures.

Model	Length	Thread Size
5812	12"	1/8" NPT(m)
5818	18"	1/8" NPT(m)
5861	36"	1/8" NPT(m)

### Extensions for Manually-Operated Grease Guns

Maximum working pressure 3000 psi.

#### Manually-Operated—Packaged

Model	Length	Thread Size
71512	12"	1/8" NPT(m)
71518	18"	1/8" NPT(m)

#### Manually-Operated—Bulk (Unpackaged)

Model	Length	Thread Size
75912CL	12"	1/8" NPT(m)
75918CL	18"	1/8" NPT(m)
75924CL	24"	1/8" NPT(m)
75936CL	36"	1/8" NPT(m)

### PowerLuber® Whip Hoses

Attaches with 7/16" UNEF fitting; 1/8" NPT(m) outlet. Working pressure 7500 psi (517 bar). For use with 14.4-volt, 12-volt, 7.2-volt and Model 1163 PowerLubers.

Model	Length
1218	18"
1224	24"
1230	30"
1236	36"

### Assemblies for Standard Hydraulic Fittings

Maximum working pressure 4500 psi.

Model	Whip Hose	Coupler	Thread Size
81725	5818/18"	5845	1/8" NPT(m)
81726	5812/12"	5845	1/8" NPT(m)
81795*	5812/12"	5845	1/8" NPT(m)

\* Includes 81980 locking sleeve.

### Assemblies for Button-Head Couplers with Swivel

Maximum working pressure 4000 psi. Includes 81606 swivel.

Model	Whip Hose	Coupler	Thread Size
3029	5812/12"	80933/large	1/8" NPT(m)
3034	5812/12"	81458/standard	1/8" NPT(m)

### Flexible & Rigid Extension Adapter

#### Model 5858

Maximum working pressure 5000 psi. Allows operator to switch from flexible to rigid extension with one hand. Overall length 13". 1/8" NPT(m).

#### Model 82228

Consists of 8" x 3/16" MPT hose, 5852 coupler and 67292 1/8" NPT(m) nipple.

#### WARNING

Whip Hoses Models 3029, 3034, 5812, 5818, 5861, 81725, 81726, 81795

#### Install as shown

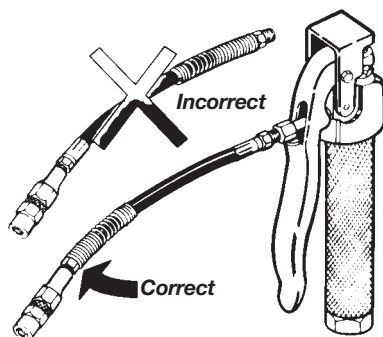

### Bulk Fittings—U.S. Threads

#### 1/8" Thread/Straight & Angle

Model	Description	Length
5000	Straight	21/32"
5003	Straight	11/4"
5200	45° angle	7/8"
5300	65° angle	29/32"
5400	90° angle	27/32"

#### 1/4" Thread/Straight & Angle

Model	Description	Length
5050	Straight 1/4" NPT	15/16"
5350	65° angle 1/4" NPT	15/32"

#### 1/4"-28 Thread/Straight & Angle

Model	Description	Length
5010	Straight—short thread	1/2"
5013	Straight—long thread	11/16"
5527	Straight—short thread	31/64"
5210	45° angle—short thread	7/8"
5410	90° angle—short thread	25/32"

### Bulk Fittings—Metric Threads

#### Metric Threads

Model	Description	Size
5175	Straight	6mm
5176	45°	6mm
5177	90°	6mm
5178	Straight	8mm
5179	45°	8mm
5180	90°	8mm
5181	Straight	10mm
5182	45°	10mm
5183	90°	10mm

### Drive-Type Fittings

#### Drive-Type Fittings

Model	Description	Length	Drive Diameter
5033	Straight	9/16"	3/16"
5385	65° angle	13/16"	3/16"

### Button-Head Fittings

- Precision-machined and case hardened for rugged wear.
- Smooth face prevents leakage and excessive wear.
- Long guide stem assures positive closing.

### Button-Head Fittings

Model	Description	Length
5701	1/8" NPT(m) thread	25/32"
5706	1/4" NPT(m) thread	53/64"

### Fitting Bushings & Angle Bodies

#### Bushings & Angle Bodies

Model	Description	Length
10461	Hex bushing	1/8" NPT(f) x 1/4" NPT(m)
10787	Face bushing	1/8" NPT(f) x 1/4" NPT(m)
20028	45° angle body	1/8" NPT(f) x 1/8" NPT(m)
20029	90° angle body	1/8" NPT(f) x 1/8" NPT(m)
20026	90° angle body	1/4"-28 (m) x 1/8" NPT(f)

### Easy-Out Tools

A combination tool used to remove worn or broken fittings and to retap holes for installation of new fittings. Tool has socket wrenches for removing both straight and angle fittings. May also be used to remove old pin-type fittings.

### Model 66953

For tapping 1/4"-28 threads and removal of both 3/8" and 5/16" hex. straight or angle fittings.

### Model 90776

For tapping 1/8" NPT threads and removal of 7/16" hex. straight or angle fittings.

### Fitting Drive Tools

#### Model 11485

Use to install straight Drive-Type Fittings only.

#### Model 11509

Use to install angle Drive-Type Fittings only.

### Special Access Coupler

#### Model 5883 90° Grease Coupler

- Provides access to difficult to reach fittings.
- Allows for easy lubrication in tight areas.

### Metric Thread Adapters

Convert any 1/4"-28 thread grease fitting to metric thread.

### Metric Thread Adapters

Model	Thread
103307E	6mm x 1/4"-28 (f)
103308E	8mm x 1/4"-28 (f)
103309E	10mm x 1/4"-28 (f)







5184

### Packaged Fittings—U.S. Threads

All the most popular fittings and sizes

#### Model 5468 Mini

Ten assorted grease fittings in three popular sizes, blister packed on one card.

#### Assortment Contents

Quantity	Description
6	1/4"-28 straight
2	1/4"-28 45°
2	1/4"-28 90°



5470

#### Model 5470 Economy

24 assorted grease fittings in six popular sizes blister packed on one card.

#### Assortment Contents

Quantity	Description
6	1/8" NPT straight
6	1/4"-28 straight, short thread
3	1/8" NPT 45° angle
3	1/4"-28 45° angle, short thread
3	1/8" NPT 90° angle
3	1/4"-28 90° angle, short thread



5470



5469

#### Model 5469 Deluxe

100 assorted grease fittings in six popular sizes. Sturdy, easy to handle transparent dispenser box has labeled and illustrated compartments.

#### Assortment Contents

Quantity	Description
20	1/8" NPT straight
40	1/4"-28 straight, short thread
10	1/4"-28 45° angle, short thread
10	1/8" NPT 65° angle
10	1/8" NPT 90° angle
10	1/4"-28 90° angle, short thread



5191

5291

#### 1/4"-28 Taper Thread Packs

#### Short Thread Grease

Model	Description
5191	Card of (10) straight fittings
5291	Card of (10) 45° angle fittings
5491	Card of (10) 90° angle fittings

#### 1/8" Pipe Thread Packs

#### Grease Fittings

Model	Description
5190	Card of (10) straight fittings
5290	Card of (10) 45° angle fittings
5490	Card of (10) 90° angle fittings

### Packaged Fittings—Metric Threads

All the most popular fittings and sizes

#### Model 5184 Mini

An assortment of three of the most used 6mm sizes and configurations blister packed on one card.

#### Assortment Contents

Quantity	Description
6	6mm straight
2	6mm 45°
2	6mm 90°

#### Model 5185 Economy

30 grease fittings in three of the most popular 6mm metric sizes blister packed on one convenient card.

#### Assortment Contents

Quantity	Description
16	6mm straight
6	6mm 45°
8	6mm 90°

#### Model 5186 Deluxe

100 assorted grease fittings in all the most popular metric sizes. Sturdy, easy to handle dispenser box has labeled and illustrated compartments.

#### Assortment Contents

Quantity	Description
40	6mm straight
20	6mm 45°
10	6mm 90°
5	8mm straight
5	8mm 45°
5	8mm 90°
5	10mm straight
5	10mm 45°
5	10mm 90°

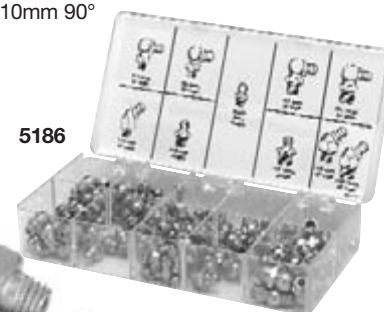

5186



5290



5490



5184

# Hand-Held Lubrication

## Packaged Grease Fittings/Wheel Bearing Packers



Our popular fitting models are packaged in a convenient 100 piece carton for your small order requirements. Order a quantity of one and receive 100 pieces of that fitting.



816

Standard Fitting Model No.	Old Model Carton 100	New Model Carton 100	5180	249154	5180C
5000	249150	5000C			
5003	249163	5003C			
5010	249144	5010C			
5013	249146	5013C			
5031	249148	5031C			
5033	249141	5033C			
5050	249164	5050C			
5175	249142	5175C			
5176	249151	5176C			
5177	249152	5177C			
5178	249147	5178C			
5179	249155	5179C			

### Lincoln Bearing Packers

Flush and pack in one operation eliminating inefficient washing and messy hand packing.

#### Model 224

Universal Bearing Packer forces out old grease while evenly injecting fresh grease. Pack bearing up to 4 1/2" I.D. Connects to standard grease coupler.

#### Model 816

Serves bearings with 5/8" to 1 1/2" I.D. This versatile, compact unit mounts on work-bench or wall. Bearing is flushed and packed by contacting fitting in packer head with power gun control valve or by high-pressure hand gun. Overall dimension: 4 1/2" high, 4" wide.

#### Model 102891

Bearing packer head only; for bench mounting or attachment to any Lincoln air-operated economy, Series 20 or Series 40 grease pump. Serves bearings 1 3/4" to 9 1/2" O.D. with minimum I.D. of 9/16". Accepts grease through fitting from high-pressure control valve or hand gun. For bench mount use 1/2" pipe flange.

#### Model 844

Serves bearings to 9 1/2" O.D. with minimum 9/16" I.D. Includes adapters to service bearings from 1" to 1 3/4" O.D. For use with 120 lb. original refinery container. Includes 84780 universal follower.

*Specifications:* Maximum pressure 800 psi. 1 ounce per stroke.

*Finish:* Drum cover in red enamel, pump head and handle in black.

*Dimensions:* Overall height 41 7/8" with standard 120 lb. drum.

#### Model 102697 Super Speed packer

Serves bearings with 5/8" to 1 1/2" I.D. with up to 3 1/4" O.D. on passenger cars, light trucks and farm vehicles. Clamps securely on 25 to 50 pound original refinery container. Primes easily and pump efficiently when using heavy greases at low temperatures. Includes 91393 follower.

*Specifications:* 21" overall height, 2 1/4" wide.

*Finish:* Drum cover in red enamel.

#### Model 102929

Same as 102697 except has larger packer head to service bearing to 9 1/2" O.D. with minimum 9/16" I.D. Includes adapter to permit servicing smaller bearings of 1" to 1 3/4" O.D. Includes 91393 follower plate.

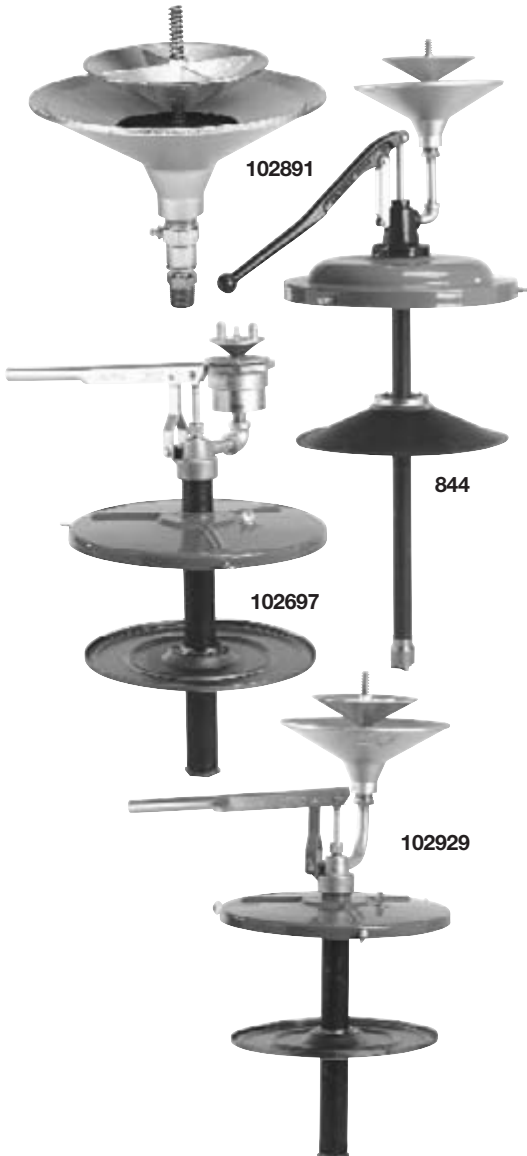

HAND-HELD LUBRICATION