

ASHCROFT®

Stainless Steel
Case Gauges

NOW WITH

PLUS!
Performance

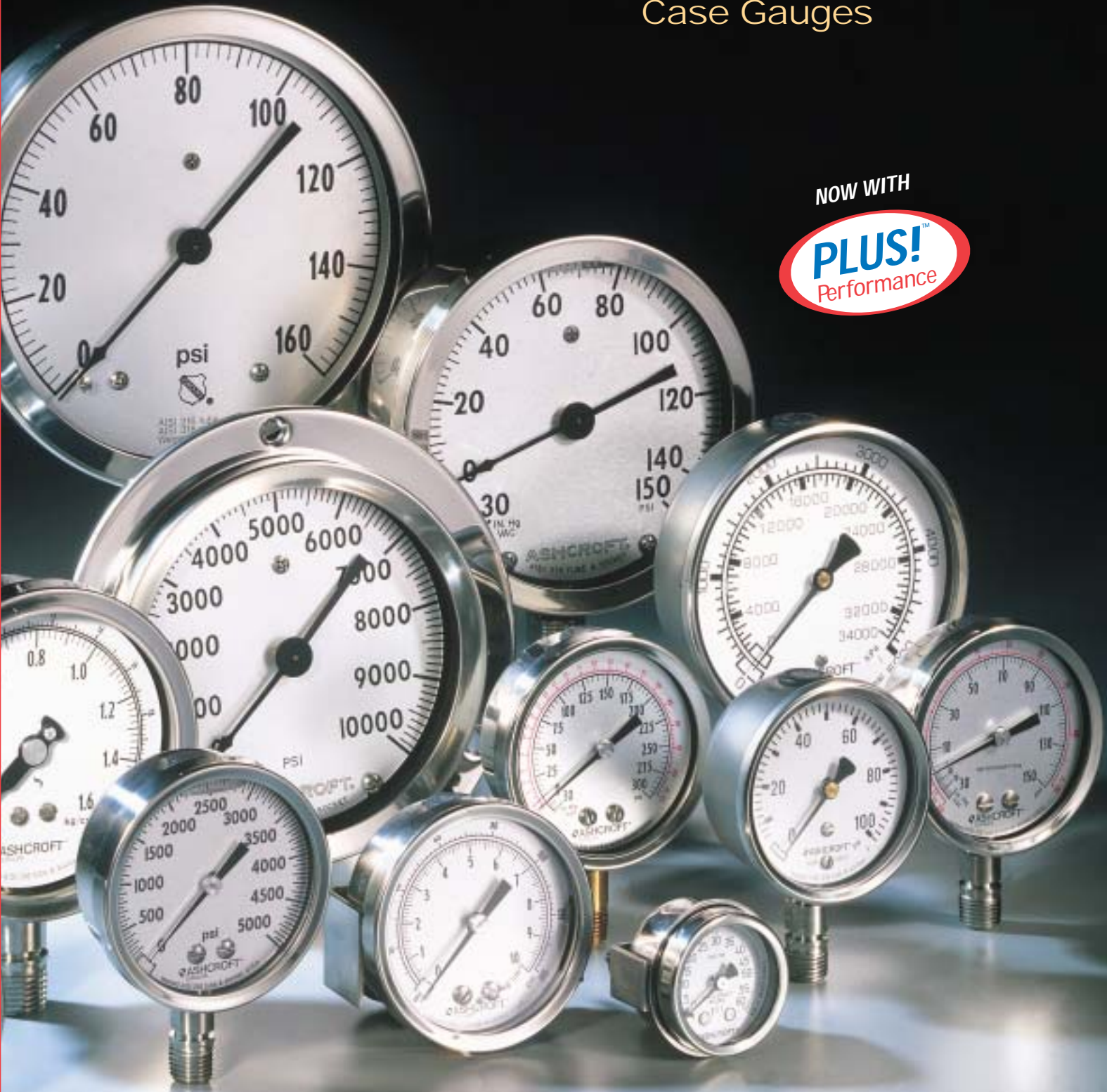

ISO 9001
REGISTERED FIRM

DRESSER

Measurement

BULLETIN SS-1

Introduction

Ashcroft® Stainless Steel Case Pressure Gauges

For demanding applications where corrosion resistance and reliable operation are critical, look to Ashcroft® stainless steel case pressure gauges to fulfill your requirements. These designs perform well in many applications where vibration, pulsation and mechanical shock are present. Offered in stainless steel, including a stainless steel case, bourdon tube, socket and movement, these gauges meet the needs of many corrosive environments.

Stainless steel gauges ensure long service life in the harshest, most demanding environments. Applications where Ashcroft stainless steel case gauges are typically used for their lasting performance include process and chemical plants, petrochemical refineries, pharmaceutical, food and beverage processing, and pulp and paper mills. Ashcroft stainless steel case gauges will perform well:

- In applications where vibration, pulsation and mechanical shock are major factors.
- In corrosive environments when a stainless steel case and ring are required.

We offer our stainless steel case pressure gauges in a selection of accuracies, materials and sizes to meet the wide-ranging requirements of the industrial marketplace. When selecting an Ashcroft stainless steel case gauge, consider the following:

Process media — Ashcroft stainless steel case gauges are available in a broad range of bourdon tube and socket materials to suit your product needs.

Pressure gauge range — A wide selection of ranges from vacuum through 15,000 psi (up to 30,000 psi on 4½" and 6" 1009) including compound and metric ranges are available.

Operating environment — All Ashcroft stainless steel case gauges have a 304 series stainless steel case and ring and are available hermetically sealed or weatherproof. They are also available liquid filled with a built-in throttle plug to help protect the gauge against pressure surges or spikes.

Accuracy requirements — Ashcroft Type 1009 gauges come standard with 1% full scale ASME Grade 1A accuracy. Ashcroft Type 1008 gauges come

standard with a 3/2/3% ASME Grade B accuracy.

Dial size — Available in 2½" through 6" and 40mm through 100mm dial sizes, Ashcroft selection of stainless steel gauge case sizes is unsurpassed.

Connections — ½ NPT, ¼ NPT, ½ NPT, JIS, BSP, and automotive connections available.

Mounting requirements — Ashcroft stainless steel case gauges are available for stem, surface or flush mounting.

Dresser Instrument offers two series of Ashcroft gauges — Type 1008 and 1009 to meet your stainless steel case requirements.

CONTENTS

Page	
2 & 3	Introduction
4 & 5	Features & Benefits
6 & 7	Other Stainless Steel Case Gauges Warranty and Movement
8 & 9	Specification Matrix
10 & 11	Product Selection and Media Application
12 & 13	1008 Range Tables
14	1009 Range Tables
15	Options
16	How to Order
17	1008 General Dimensions
18 & 19	1009 General Dimensions



Introduction

Ashcroft® Stainless Steel Case Pressure Gauges



Features & Benefits

Ashcroft® Stainless Steel Case 1008 Pressure Gauges

Type 1008 Stainless Steel Case Gauge — 63mm and 100mm Case Sizes

These stainless steel case gauges offer reliable performance under the most demanding applications where vibration and pulsation dominate the operating conditions. They are offered in a selection of metric case sizes in stem, surface or panel mounting to meet a variety of requirements.

63mm and 100mm Type 1008 pressure gauge ranges, with the patented *PowerFlex™* movement, are designed for maximum life under pulsating service conditions.

The 63mm and 100mm sizes of our Type 1008 gauges share some unique features that offer benefits not available elsewhere.

- Because the socket of the 1008S is welded to the case, the gauge is stronger and more durable, with less risk of liquid-filled gauges leaking. And because there are no screws needed to hold the system in place, we eliminate leak paths when the gauge is liquid filled.
- The patented *PowerFlex™* movement offers superior shock, vibration and pulsation performance.
- True Zero™ indication with no stop pin – a unique safety benefit.

- Because weld nuts are standard on all back-connect gauges, you will enjoy the flexibility to panel mount any back-connect gauge.
- The date of manufacture is coded on the socket of each gauge for quality assurance.*
- We ship all gauges in a unique carton-within-carton package, so your gauges arrive in good condition.
- These Ashcroft gauges are made in the USA — for the best availability and quality! Need it now? Ashcroft Gold Service offers 2-5 day shipment.

40mm and 50mm Case Sizes

The 40mm and 50mm sizes of our Type 1008 gauges share some of their own unique features. These gauges bring all stainless steel construction (case, ring, bourdon tube and socket) to the requirement for smaller dial diameters.

Features of the 40mm and 50mm 1008 gauges include:

- Stainless steel case and ring for maximum resistance to corrosion.
- 316 stainless steel bourdon tube and socket for maximum resistance to corrosion.
- Available with front flange or U-clamp for panel mounting.
- Available with *PLUS!™* or liquid fill in lower or back connections for better performance and longer gauge life in pulsating and vibrating applications.
- Ranges from vacuum through 15,000 psi, including compound.

Type 1009 Stainless Steel Case Gauge — 2½" and 3½" Case Sizes

The Type 1009 Duralife® gauge in 2½" and 3½" case sizes represents another technological breakthrough in gauge manufacture. Duralife® 1009 gauges provide significant features and benefits for many applications and are offered in stem, surface or panel mount configurations.

The combination of features in the 1009 Ashcroft Duralife® gauge reflects the finest in gauge technology for



Type 1008 shown

*Excludes 1008A

Features & Benefits

Ashcroft® Stainless Steel-Case 1009 Pressure Gauges

vibration, shock and pulsation applications. Pressure ranges from vacuum through 15,000 psi, including compound, are available. Metric ranges are also offered. All 2½" and 3½" Duralife® gauges are manufactured to ASME Grade 1A accuracy of 1% over the entire dial arc. They offer zero and span adjustments and can be recalibrated in the field.

The 2½" and 3½" Type 1009 Duralife® gauges share some unique features that offer benefits not available elsewhere.

- Because the socket is welded to the case, the gauge is stronger and more durable, with less risk of liquid-filled leaking since there are no screws needed to hold the system in place. Potential leak paths are eliminated.

- The patented *PowerFlex™* movement offers superior shock, vibration and pulsation performance, resulting in outstanding durability.
- The True Zero™ indication with no stop pin is a unique safety benefit.
- With weld nuts standard on all back-connect gauges, you have the flexibility to panel mount any back-connect gauge.
- An optional external adjust or Easy Zero™ feature on the 3½" 1009 is offered on both dry and liquid filled versions. Adjustment tolerances are ±5% of full scale range.
- Each gauge is date coded on the socket for quality assurance.
- We ship all gauges in a unique carton-within-carton package, so your gauges arrive in good condition — far fewer gauges are received out of calibration with our "leading-edge" packaging method.

- Type 1009S Duralife® gauges are all-stainless steel construction for maximum resistance to corrosion.
- Because these gauges are fully recalibratable, there is no need to purchase a new gauge if recalibration is needed — this benefit includes zero and span adjustments. (Consult ASME B40.1 for gauge life and recalibration.)
- Five-Year Warranty gives you the best total value.
- Ashcroft Duralife® gauges are made in the USA — for the best availability and quality!

4½" & 6" Case Sizes

The 4½" and 6" sizes of our Type 1009 gauges share some of their own unique features. Built for long life and sustained accuracy under the most adverse operating conditions, these gauges are available with many features that offer benefits you won't find elsewhere:

- Stainless steel case and ring for maximum resistance to corrosion.
- Adjustable micrometer pointer for field recalibration.
- Rotary geared movement for field linearity adjustment.
- Variety of bourdon tube materials to meet many different application requirements.
- Available liquid filled in lower or back connections for better performance and longer gauge life in pulsating and vibrating applications.
- Pressure ranges from vacuum through 30,000 psi.



Type 1009 shown

Other Stainless Steel Case Gauges

Ashcroft® Stainless Steel Case Pressure Gauges

PLUS!™ Performance

An exclusive, new, optional feature provides virtually liquid-filled performance in a dry gauge.

The Ashcroft PLUS!™ feature is a patent-pending design incorporated into the industry-standard Ashcroft pressure gauge.

Historically, pulsation and vibration have reduced gauge life and made gauges difficult to read.

Customers have had no alternative to liquid-filled gauges to solve vibration and pulsation problems, until now!

Advantages Versus Liquid-Filled Gauges

- Saves money
 - Lower purchase price versus liquid-filled gauges
 - Eliminates costly specialty fills
 - Allows easy standardization to reduce misapplications
- Reduces possibility of leaks
- Lighter weight...easier to handle
- Eliminates liquid-fill lines...easier to read
- Easy recalibration
- Wider ambient temperature range than glycerin
- Eliminates disposal and environmental issues

Advantages Versus Dry Gauges

- Steady pointer...same as liquid-filled gauges
- 100% longer life gauges...reduces gauge usage 50%!

Hydraulic Gauges

These gauges are especially suitable for applications on hydraulic presses, pumps and systems using high-pressure hydraulic fluids. 4½" and 6" Type 1009 gauges for this application are offered with a throttle plug and slotted link to protect the movement and system of the gauge from severe pressure spikes and surges. A liquid-filled gauge is also available to help protect internal moving parts of the gauge.

The 63mm and 100mm Type 1008 gauges and 2½" and 3½" Type 1009 gauges employing the unique Power Flex™ movement and a throttle plug are ideally suited for hydraulic applications where severe service is a consideration. Available in dry PLUS!™ or liquid-filled versions, these gauges will meet your severe application needs.

Refrigeration Gauges

Available with 63mm and 100mm Type 1008 gauges and 2½" through 6" Type 1009 gauges, these Ashcroft gauges have corresponding temperature scales for refrigerants 11, 12, 22, 114, 123, 134A, 500, 502 and ammonia. To meet the stringent requirements of an ammonia refrigeration system, a gauge with a stainless steel tube and socket is recommended. Both 4½" and 6" Type 1009 gauges can be furnished with a stainless steel tube and a steel or stainless steel socket.

Ashcroft stainless steel case refrigeration gauges come equipped with all the features made available on the standard product.

Receiver Gauges

Used in conjunction with pneumatic transmitters, Ashcroft® receiver gauges indicate pressure, temperature, flow or any information that can be transmitted by proportional variations in air pressure.

For information concerning other receiver gauges offered, consult Customer Service, Stratford, CT.

Liquid-Filled Gauges

Constant lubrication of the movement minimizes wear on all moving gauge parts. The liquid fill, usually glycerin or silicone, acts as a dampening agent for the bourdon tube and movement, thus reducing gauge pointer flutter. Under adverse environmental conditions, corrosive elements may attack internal parts and shorten gauge service life. Liquid filling a gauge helps prevent corrosive effects caused by adverse environments. All liquid-filled gauges 30 psi and above are fitted with throttle plugs to provide additional dampening.

Ashcroft stainless steel case gauges with dial sizes from 40mm through 100mm and 2½" through 6" are available liquid filled or field liquid fillable. Simply specify XLJ to order a stainless steel-case gauge that can be filled in the field. Gauge accuracy on liquid filled Type 1009 gauges with 2½", 3½" or 100mm dial size is up to 1.5% full scale.



Warranty & Movement

Duralife® 2½", 3½", 100mm
Type 1009 gauges

Panel Gauges

Ashcroft stainless steel case panel mounted gauges with back connections are available with a three hole front flange or a U-clamp. Generally, a front flange is used when there is limited access to the back of the panel.

A U-clamp is the most common method of panel mounting when there is access to the back of the panel. Ashcroft back connect stainless steel gauges are available for panel mounting with dial sizes from 40mm through 100mm and 2½" thru 6". The back connect 2½" and 3½" Duralife 1009 gauges and the 63mm and 100mm 1008 gauges come standard with weld nuts on the back of the case. This feature allows for easy conversion to panel mounting with either a U-clamp or front flange. The 2½" and 3½" 1009 lower connect gauges are also available for wall mounting with an available back flange.



The patented pressure system consists of a *PowerFlex™* movement and unitized bourdon tube assembly that provides increased gauge life and stability. This truly unique design has a stainless steel movement suspended between the bourdon tube and socket with a link wire. This spring suspension significantly reduces the level of forces transmitted to the precision moving parts, greatly extending the wear life in applications where vibration and pulsation are constant factors. Since the system is welded to the case, there are no screws to loosen under conditions of pulsation and vibration.



Duralife C tube with
PowerFlex™ movement
furnished with ranges to
600 psi.

Helical tube with
PowerFlex™ movement
furnished with ranges
from 800 psi and above.

All 2½", 3½" and 100mm Type 1009 Duralife gauges come standard with a limited five year warranty. For a copy of our warranty call or write:

Dresser Instrument
Dresser, Inc.
250 East Main Street
Stratford, CT 06614-5145
203-378-8281

Ask for Customer Service

Specification Matrix

Ashcroft® Stainless Steel Case Pressure Gauges



Specifications	Type 1008, 40mm	Type 1008, 50mm	Type 1008A, 63-100mm	Type 1008S
Accuracy	3-2-3% ASME Grade B	3-2-3% ASME Grade B	3-2-3% ASME Grade B	3-2-3% AS
Case Style	Open Front		Open Front	Open
Case Material	304 Stainless Steel		304 Stainless Steel	304 Stair
Dial Size (Code)	40mm (40)	50mm (50)	63mm (63), 100mm (10)	63mm (63),
Dial Material & Color	Aluminum, white background w/black markings			
Ring Type	304 Stainless Steel Push-In		304 Stainless Steel Crimped	304 Stainless
Bourdon Tube (Code)	316 Stainless Steel (S)		Bronze (A)	316 Stainle
Socket Material	316 Stainless Steel		Brass (socket O ring standard)	316 SS, Socke
Range Limits	Vac/15,000 psi-(40mm)	Vac/15,000 psi-(50mm)	Vac/6000 psi	Vac/15
Connection Size (Code)	½ NPT (01)	½ NPT (01) ¼ NPT (02)	¼ NPT (02)	¼ NPT (02),
Connection Location	Lower (L), Back (B)		Lower (L), Back (B)	Lower (L)
Mounting	Stem, Flush		Stem, Flush	Stem
Movement	300 Series SS (conventional)		Brass (<i>PowerFlex™</i>) with polyester segment	300 Series SS with polyes
Pointer	Nonadjustable (Aluminum)		Nonadjustable (Aluminum)	Nonadjustabl
Window	Glass		Polycarbonate	Polycar
Warranty	One Year		One Year	One
Options	Code			
<i>PLUS!</i> ™ Performance	(LL)	N/A	N/A	Avai
Glycerin Fill	(L)	Standard	Standard	Star
Silicone Fill	(GV)	N/A	Available	Avai
Halocarbon Fill	(GX)	N/A	N/A	Avai
Weatherproof, hermetic seal	(LJ)	Available	Available	Avai
U-Clamp	(UC)	Available	Available	Avai
Front Flange Ring	(FF)	Available	Available	Avai
Retrofit Flange	(RF)	N/A	Available	Avai
Back Flange	(FW)	N/A	N/A	N
Wall Mounting Bracket	(BF)	N/A	N/A	N
Acrylic Window	(PD)	N/A	N/A	N
Polycarbonate Window	(PD)	Standard on liquid filled gauge		Star
Shatterproof Glass	(SG)	Available	N/A	N



63-100mm	Type 1009, 2½"-3½"	Type 1009, 100mm (XMG)	Type 1009, 4½"	Type 1009, 6"
ME Grade B	1% ASME Grade A	1% ASME Grade A	1% ASME Grade A	1% ASME Grade A
Front	Open Front	Open Front	Open Front	Open Front
less Steel	304 Stainless Steel	304 Stainless Steel	304 Stainless Steel	304 Stainless Steel
100mm (10)	2½" (25), 3½" (35)	100mm (10)	4½" (45)	6" (60)
	Brushed Aluminum, w/black markings	Aluminum, white background w/black markings	Brushed Aluminum, w/black markings	
Steel Crimped	304 Stainless Steel Bayonet	304 Stainless Steel Bayonet	304 Stainless Steel Bayonet	304 Stainless Steel Bayonet
ss Steel (S)	316 Stainless Steel	316 Stainless Steel (SW)	Bronze Tube, Brass Socket (A)	4130 Alloy Steel Tube & Socket (B)
			316 SS Tube, Steel Socket (R)	316 SS Tube & Socket (S)
			Monel Tube & Socket (P)	
Socket Weld to Case	Bronze, Socket Weld to Case (AW) 316 SS, Socket Weld to Case (SW)	316 SS, Socket Welded to Case		
000 psi	Vac/15,000 psi	Vac/15,000 psi	Vac/30,000 psi	Vac/30,000 psi
¼ NPT (04)*	¼ NPT (02), ½ NPT (04)*	½ NPT (04)	¼ NPT (02), ½ NPT (04)	¼ NPT (02), ½ NPT (04)
, Back (B)	Lower (L), Back (B)	Lower (L)	Lower (L), Back (B)	Lower (L), Back (B)
Flush	Stem, Surface, Flush	Stem, Surface	Stem, Surface, Flush	Stem, Surface, Flush
(PowerFlex™) er segment	300 Series SS (PowerFlex™)	300 Series SS (PowerFlex™)	400 Series SS (Conventional)	400 Series SS (Conventional)
e (Aluminum)	Adjustable (Aluminum)	Micrometer Adjustable (Aluminum)	Micrometer Adjustable (Aluminum)	Micrometer Adjustable (Aluminum)
arbonate	Polycarbonate	Shatterproof Glass	Glass	Glass
Year	Five Years	Five Years	One Year	One Year
able	Available	Available	Available	Available
ard	Standard	Standard	Standard	Standard
able	Available	Available	Available	Available
able	Available	Available	Available	Available
able	Available	Available	Available	Available
able	Available	Available	Available	Available
able	Available	Available	Available	Available
able	Available	Available	Available	Available
able	Available (3½")	N/A	Available	N/A
/A	Available	Available	N/A	N/A
/A	N/A	N/A	Available	Available
/A	N/A	N/A	Available	Available
ard	Standard	Available	N/A	N/A
/A	Available	Standard	Available	Available

* 3½" or 100mm lower only.

Product Selection Information

Ashcroft® Stainless Steel Case Pressure Gauges

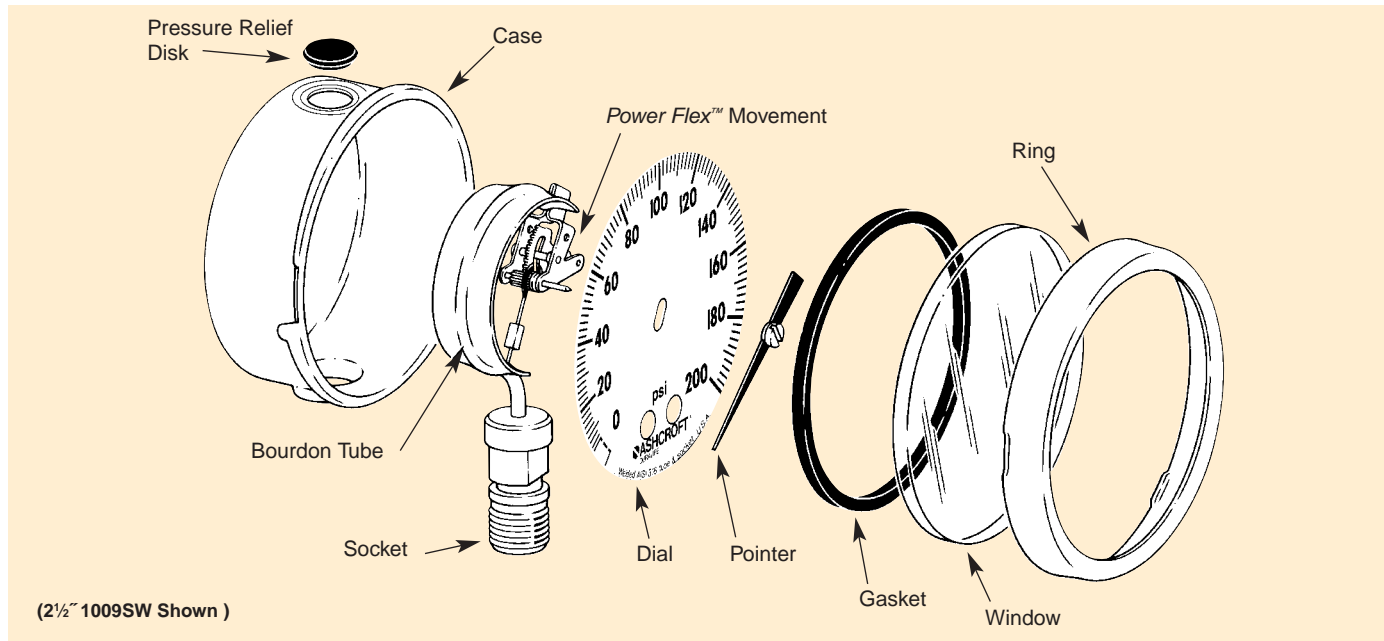

Consult ASME B40.1 for guidance in gauge selection

WARNING: To prevent misapplication, pressure gauges should be selected considering media and ambient operating conditions. Improper application can be detrimental to the gauge, causing failure and possible personal injury or property damage. The information contained in this catalog is offered as a guide to assist in making the proper selection of a pressure gauge. Additional information is available from Dresser Instrument Division or www.ashcroft.com.

Pressure Ranges:

As recommended by ASME B40.1, select a gauge with a full scale pressure range of approximately twice the normal operating pressure. The maximum operating pressure should not exceed approximately 75% of the full scale range. Failure to select a gauge range within these criteria may ultimately result in fatigue failure of the bourdon tube.

Operating Conditions:

The operating conditions to which a gauge will be subjected must be considered. If the gauge will be subjected to severe vibration or pressure pulsation, liquid filling the gauge will be necessary to obtain normal product life.

Other than discoloration of the dial and hardening of the gasketing that may occur as ambient temperatures exceed 150°F, stainless steel gauges

(that are not liquid filled) can withstand continuous ambient temperatures as high as 250°F. Liquid-filled gauges can withstand ambient temperatures up to 200°F. Accuracy will be affected by approximately 1.5% per 100°F.

Gauges with welded joints will withstand 750°F (450°F with silver brazed joints) for short times without rupture, although other parts of the gauge will be destroyed and calibration will be lost.

Proper selection of the bourdon system material is dependent on the process fluid to which the system will be subjected. If the correct material is not available, the use of a diaphragm seal may be necessary to protect the system from the process fluid. Liquid filled gauges with throttle plugs are recommended for the discharge side of positive displacement pumps.

Pressure Elements:

Available in a wide variety of materials, including: phosphor bronze, alloy steel, 316 stainless steel and K Monel.

Cases:

Ashcroft stainless steel case gauges have 304 stainless steel cases. The 2½", 3½", 100mm 1009 and the 63mm and 100mm 1008 are field convertible. These gauges can be converted to hermetically sealed, weatherproof or liquid filled by changing the fill plug and adding a throttle plug. The 40mm and 50mm 1008 gauges can be furnished from the factory hermetically sealed,

weatherproof or liquid fillable. Specify the XLJ variation. With the exception of 40mm and 50mm 1008 gauges, all **dry** stainless steel gauges come standard with a vented pressure relief disc. These gauges with the vented plug **are not** weatherproof or hermetically sealed. If a weatherproof or hermetically sealed gauge is required, specify the XLJ variation and your gauge will be shipped with a solid nonventing plug.

Rings:

The ring, which retains the window, is push-in, crimped or bayonet (cam) depending on the type number.

Movements:

Movements are designed and materials of construction selected to reduce friction and extend wear life.

Dials:

Dials are uniformly graduated and have highly legible black markings. All 1009 gauges, with the exception of 1009 XMG, have a brushed aluminum dial with black markings. Type 1008 gauges have a white dial with black markings.

Windows:

Depending on the size and type, Ashcroft stainless steel case gauges are available with polycarbonate, acrylic, shatterproof glass or glass windows.

Pointers:

Depending on the type, Ashcroft stainless steel gauges are available with adjustable or fixed pointers.

Media Application Table

Ashcroft® Stainless Steel Case Pressure Gauges

The media being measured must be compatible with the wetted parts of the pressure instrument. To use the chart below, locate the media whose pressure is to be measured and select a suitable material from those available. Diaphragm seal information is contained in Bulletin DS-1. This is a simplified chart and

assumes the media temperature is below 200°F. *PLUS!* option, throttling devices and/or a liquid-filled instrument are recommended in applications with pulsation or vibration. These recommendations are only a guide, as service life is dependent on temperature, concentrations, catalysts that may be added, or

other conditions beyond our control. Consult Stratford, CT Customer Service for specific applications and for any media not listed. More complete corrosion guide available on our website at www.ashcroft.com in the Application Data Section.

Media Application	Pressure Instrument Material				
	Brass or bronze	Steel	Stainless steel	Monel	Diaphragm seals*
Acetone	•		•	•	
Acetic Acid <40%			•		
Acetic Anhydride					•
Acetylene (Dry)		•	•		
Acrolein 100%					•
Air	•	•	•	•	
Alcohol, Ethyl	•		•	•	
Alum. Chloride >10%					•
Alum. Sulfate 10-50%					•
Ammonia Gas (Dry)		•	•		
Ammonium Chloride <40%					•
Ammonium Nitrate <50%			•		
Ammonium Sulfate <60%					•
Aniline >99%			•		
Argon	•	•	•	•	
Beer			•		
Benzidine >99%					•
Benzene <50%			•	•	
Benzoic Acid <70%					•
Boric Acid <25%			•		
Bromine (Dry)					•
Butane	•	•	•	•	
Butyric Acid <10%					•
Calcium Chloride <80%					•
Calcium Hydroxide <50%					•
Carbon Dioxide	•	•	•	•	
Carbon Monoxide >99%	•	•	•	•	
Chlorine (Dry)					•
Chlorine (Moist)					•
Chloroform (Dry)			•	•	
Chromic Acid					•
Citric Acid 10-50%			•		
Corn Oil			•		

Media Application	Pressure Instrument Material				
	Brass or bronze	Steel	Stainless steel	Monel	Diaphragm seals*
Crude Oil (Sour)				•	
Crude Oil (Sweet)			•	•	
Ethyl Acetate					•
Ethylene Oxide >99%	•		•	•	
Ferric Chloride <40%					•
Ferric Sulfate <10%			•		
Ferrous Chloride <30%					•
Ferrous Sulfate <50%					•
Fluorine Gas (Dry)				•	
Formaldehyde <95%				•	
Formic Acid					•
Freons		•	•		
Furfural <10%					•
Gasoline			•		
Glycerin >99%	•	•	•	•	
Hydrobromic Acid					•
Hydrochloric Acid					•
Hydrofluoric Acid					•
Hydrofluosilic Acid					•
Hydrogen ①	•		•		
Hydrogen Peroxide <50%					•
Kerosene	•	•	•	•	
Lactic Acid <70%			•		
Magnesium Chloride <40%					•
Mercuric Chloride <60%					•
Mercury >99%			•		
Milk			•		
Naphtha >99%	•	•	•	•	
Naphthalene >99%			•	•	
Nickel Chloride >99%					•
Nitric Acid <95%			•		
Nitrogen	•	•	•	•	
Oleic Acid					•

Media Application	Pressure Instrument Material				
	Brass or bronze	Steel	Stainless steel	Monel	Diaphragm seals*
Oxalic Acid					•
Oxygen (Gas) ②			•	•	
Palmitic Acid >99%			•		
Phosphoric Acid <80%			•		
Picric Acid <10%			•		
Propane (Dry)		•	•	•	
Sea Water (Flowing)				•	
Silver Nitrate <70%					•
Sodium Bicarbonate <20%			•	•	
Sodium Bisulfate <30%					•
Sodium Carbonate <40%			•	•	
Sodium Chromate <60%	•	•	•	•	
Sodium Cyanide		•	•		
Sodium Hydroxide < 40%				•	
Sodium Hypochlorite <25%					•
Sodium Phosphate, Tri <60%	•	•	•	•	
Sodium Silicate <50%		•	•	•	
Sodium Sulfide <50%					•
Stannous Chloride <10%					•
Steam (Use siphon)	•	•	•	•	
Stearic Acid			•		
Sulfur Dioxide (Dry) >99%					•
Sulfur Trioxide (Dry) >99%					•
Sulfuric Acid					•
Tannic Acid <80%		•	•	•	
Tartaric Acid <50%			•	•	
Tin Chloride (ous) <10%					•
Toluene >99%	•	•	•	•	
Turpentine >98%	•	•	•	•	
Water (Tap)	•	•	•	•	
Whiskey			•		
Zinc Chloride <25%					•
Zinc Sulphate <40%					•

① Over 1000 psi – entire system must be 316 stainless steel. Applicable only to hydrogen.

② Monel and 316 stainless steel are acceptable for oxygen service, provided the instrument has been cleaned for oxygen service and is free from oil.

* Any standard Bourdon tube material may be used in conjunction with a diaphragm seal, but the gauge selection should take into consideration the corrosive environment in which it is to operate. For diaphragm seals see Bulletin DS-1.

Range Tables

Ashcroft® 1008 Stainless Steel Case, Dual and Single Scale
40mm, and 50mm Pressure Gauges

Standard Single Scale Ranges

Pressure – Single Scale psi		
Range	Figure interval	Minor graduation
0/15	3	0.5
0/30	5	0.5
0/60	10	1
0/100	20	2
0/160	20	2
0/200	40	5
0/300	50	5
0/400	50	5
0/600	100	10
0/800	200	20
0/1000	200	20
0/1500	300	50
0/2000	400	50
0/3000	500	50
0/5000	1000	100
0/6000	1000	100
0/7500	1000	100
0/10,000	2000	200
0/15,000	3000	500

Compound – Single Scale				
Range	Figure interval		Minor graduation	
	in. Hg	psi	in. Hg	psi
30" Hg/15 psi	5	3	1	0.5
30" Hg/30 psi	10	5	1	0.5
30" Hg/60 psi	10	10	2	1
30" Hg/100 psi	30	20	5	2
30" Hg/150 psi	30	30	15	5
30" Hg/300 psi	30	50	30	5

Vacuum – Single Scale		
Range	Figure interval	Minor graduation
30/0 in Hg	5 in.	0.5 in.

Metric Single Scale Ranges

Pressure – Single Scale kg/cm ² , bar, kPa						
Range		Figure interval	Minor grads.	Range kPa	Figure interval	Minor grads.
kg/cm ²	bar					
0-1	0-1	0.2	0.02	0-100	20	2
0-2	0-2	0.2	0.02	0-160	20	2
0-2.5	0-2.5	0.5	0.05	0-250	50	5
0-4	0-4	0.5	0.05	0-400	50	5
0-6	0-6	1	0.1	0-600	100	10
0-10	0-10	2	0.2	0-1000	200	20
0-16	0-16	2	0.2	0-1600	200	20
0-25	0-25	5	0.5	0-2500	500	50
0-40	0-40	5	0.5	0-4000	500	50
0-60	0-60	10	1	0-6000	1000	100
0-100	0-100	20	2	0-10,000	2000	200
0-160	0-160	20	2	0-16,000	2000	200
0-250	0-250	50	5	0-25,000	5000	500
0-400	0-400	50	5	0-40,000	5000	500
0-600	0-600	100	10	0-60,000	10,000	1000
0-1000	0-1000	200	20	0-100,000	20,000	2000
0-1600	0-1600	200	20	0-160,000	20,000	2000

Compound – Single Scale kg/cm ² , bar, kPa						
Range		Figure interval	Minor grads.	Range kPa	Figure interval	Minor grads.
kg/cm ²	bar					
-1/0/1	-1/0/1	0.2	0.02	-100/100	20	2
-1/0/1.5	-1/0/3	0.5	0.05	-100/150	50	5
-1/0/3	-1/0/3	0.5	0.05	-100/300	50	5
-1/0/5	-1/0/5	1	0.1	-100/500	100	10
-1/0/9	-1/0/9	2	0.2	-100/900	200	20
-1/0/15	-1/0/15	3	0.5	-100/1500	300	50
-1/0/24	-1/0/24	5	0.5	-100/2400	500	50

Vacuum – Single Scale kg/cm ² , bar, kPa						
Range		Figure interval	Minor grads.	Range kPa	Figure interval	Minor grads.
kg/cm ²	bar					
-1/0	-1/0	0.2	0.02	-100/0	20	2

Metric & psi Dual Scale Ranges*

Pressure – Dual Scale				
Range (outer scale is psi)	Figure interval		Minor graduation	
	kg/cm ²	psi	kg/cm ²	psi
0/1 kg/cm ² -15 psi	0.2	3	0.02	0.5
0/2 kg/cm ² -30 psi	0.5	5	0.05	0.5
0/4 kg/cm ² -60 psi	1	10	0.1	1
0/7 kg/cm ² -100 psi	1	20	0.2	2
0/11 kg/cm ² -160 psi	2	20	0.2	2
0/14 kg/cm ² -200 psi	2	40	0.5	5
0/21 kg/cm ² -300 psi	5	50	0.5	5
0/28 kg/cm ² -400 psi	5	50	0.5	5
0/42 kg/cm ² -600 psi	10	100	1	10
0/50 kg/cm ² -800 psi	10	200	1	20
0/70 kg/cm ² -1000 psi	10	200	2	20
0/105 kg/cm ² -1500 psi	20	300	2	50
0/140 kg/cm ² -2000 psi	20	400	2	50
0/210 kg/cm ² -3000 psi	50	500	5	50
0/350 kg/cm ² -5000 psi	50	1000	10	100
0/420 kg/cm ² -6000 psi	100	1000	10	100
0/500 kg/cm ² -7500 psi	100	1000	10	100
0/700 kg/cm ² -10,000 psi	100	2000	20	200
0/1050 kg/cm ² -15,000 psi	200	3000	20	500

Range	Figure interval		Minor graduation	
	bar	psi	bar	psi
0/1 bar-15 psi	0.2	3	0.02	0.5
0/2 bar-30 psi	0.5	5	0.05	0.5
0/4 bar-60 psi	1	10	0.1	1
0/7 bar-100 psi	1	20	0.2	2
0/10 bar-160 psi	2	20	0.2	2
0/14 bar-200 psi	2	40	0.5	5
0/20 bar-300 psi	5	50	0.5	5
0/27 bar-400 psi	5	50	0.5	5
0/40 bar-600 psi	10	100	1	10
0/55 bar-800 psi	10	200	1	20
0/70 bar-1000 psi	10	200	2	20
0/100 bar-1500 psi	20	300	2	50
0/140 bar-2000 psi	20	400	2	50
0/200 bar-3000 psi	50	500	5	50
0/340 bar-5000 psi	50	1000	10	100
0/400 bar-6000 psi	100	1000	10	100
0/500 bar-7500 psi	100	1000	10	100
0/700 bar-10,000 psi	100	2000	20	200
0/1000 bar-15,000 psi	200	3000	20	500

Range	Figure interval		Minor graduation	
	kPa	psi	kPa	psi
0/100 kPa-15 psi	20	3	2	0.5
0/200 kPa-30 psi	50	5	5	0.5
0/400 kPa-60 psi	100	10	10	1
0/700 kPa-100 psi	100	20	20	2
0/1000 kPa-160 psi	200	20	20	2
0/1400 kPa-200 psi	200	40	50	5
0/2000 kPa-300 psi	500	50	50	5
0/2700 kPa-400 psi	500	50	50	5
0/4000 kPa-600 psi	1000	100	100	10
0/5500 kPa-800 psi	1000	200	100	20
0/7000 kPa-1000 psi	1000	200	200	20
0/10,000 kPa-1500 psi	2000	300	200	50
0/14,000 kPa-2000 psi	2000	400	200	50
0/20,000 kPa-3000 psi	5000	500	500	50
0/34,000 kPa-5000 psi	5000	1000	1000	100
0/40,000 kPa-6000 psi	10,000	1000	1000	100
0/50,000 kPa-7500 psi	10,000	1000	1000	100
0/70,000 kPa-10,000 psi	10,000	2000	2000	200
0/100,000 kPa-15,000 psi	20,000	3000	2000	500

*Inner scale is dominant

Range Tables

Ashcroft® 1008 Stainless Steel Case, Dual and Single Scale
63mm and 100mm Pressure Gauges

Metric & psi Dual Scale Ranges*

Pressure					
Units of Measurement				Figure interval	Minor graduation
inner psi	outer kg/cm ²	outer bar	outer kPa		
0/15	1	1	100	1	0.2
0/30	2	2	200	5	0.5
0/60	4	4	400	5	1
0/100	7	7	700	20	2
0/160	11	10	1100	20	2
0/200	14	14	1400	20	2
0/300	21	20	2000	30	5
0/400	28	27	2800	50	10
0/600	42	42	4000	100	10
0/800	50	50	5500	100	20
0/1000	70	70	7000	100	10
0/1500	105	100	10,000	200	20
0/2000	140	140	14,000	200	20
0/3000	210	200	20,000	300	50
0/5000	350	320	34,000	500	50
0/6000	420	400	40,000	1000	100
0/7500	520	520	50,000	1000	100
0/10,000	700	700	70,000	1000	100
0/15,000	1050	1050	100,000	2000	200

*Inner scale is dominant

Standard Single Scale Ranges

Pressure		
Units psi	Figure interval	Minor graduation
0/15	3	0.5
0/30	5	0.5
0/60	10	1
0/100	20	2
0/160	20	2
0/200	40	5
0/300	50	5
0/400	50	5
0/600	100	10
0/800	100	10
0/1000	200	10
0/1500	200	20
0/2000	400	20
0/3000	500	50
0/5000	1000	100
0/6000	1000	100
0/7500	1000	100
0/10,000	2000	100
0/15,000	2000	200

Vacuum		
Units in. Hg	Figure int.	Minor grad.
30/0	5 in.	0.5 in.

Compound		
Units	Figure interval	
	in. Hg	psi
30" Hg/15 psi	5	3
30" Hg/30 psi	10	5
30" Hg/60 psi	10	10
30" Hg/100 psi	30	10
30" Hg/150 psi	30	20
30" Hg/300 psi	30	50

Metric Single Scale Ranges

Pressure						
Units of Measurement		Figure interval	Minor graduation	Unit of measure	Figure interval	Minor graduation
kg/cm ²	bar			kPa		
0/1	0/1	0.1	0.01	0/100	10	1
0/1.6	0/1.6	0.2	0.02	0/160	20	2
0/2.5	0/2.5	0.5	0.05	0/250	50	5
0/4	0/4	0.5	0.05	0/400	50	10
0/6	0/6	0.5	0.1	0/600	50	10
0/10	0/10	1	0.1	0/1000	100	10
0/16	0/16	2	0.2	0/1600	200	20
0/25	0/25	5	1	0/2500	500	50
0/40	0/40	5	1	0/4000	500	100
0/60	0/60	5	1	0/6000	500	100
0/100	0/100	20	2	0/10,000	1000	100
0/160	0/160	20	2	0/16,000	2000	200
0/250	0/250	50	5	0/25,000	5000	500
0/400	0/400	50	10	0/40,000	5000	1000
0/600	0/600	50	10	0/60,000	5000	500
0/1000	0/1000	100	10	0/100,000	10,000	1000
0/1600	0/1600	200	20	0/160,000	20,000	2000

Vacuum						
		Figure interval	Minor graduation		Figure interval	Minor graduation
-1/0	-1/0	0.1	0.01	-100/0	10	1

Compound						
		Figure interval	Minor graduation		Figure interval	Minor graduation
-1/0/1.5	-1/0/1.5	0.2	0.02	-100/0/150	50	5
-1/0/3	-1/0/3	0.5	0.05	-100/0/300	50	5
-1/0/5	-1/0/5	0.5	0.1	-100/0/500	50	10
-1/0/9	-1/0/9	1	0.1	-100/0/900	100	10
-1/0/15	-1/0/15	2	0.2	-100/0/1500	200	20
-1/0/24	-1/0/24	5	0.5	-100/0/2400	500	50

Range Tables

Ashcroft® 1009 Stainless Steel Case

2½", 3½", 4½", 6" and 100mm Pressure Gauges

Standard Ranges

Pressure		
psi	Figure interval	Minor graduation
0/15	1	0.2
0/30	5	0.5
0/60	5	1
0/100	10	1
0/160	20	2
0/200	20	2
0/300	30	5
0/400	50	5
0/600	50	10
0/800	100	10
0/1000	100	10
0/1500	200	20
0/2000	200	20
0/3000	300	50
0/5000	500	50
0/6000	1000	100
0/7500	1000	100
0/10,000	1000	100
0/15,000	2000	200
0/20,000	2000	200
0/30,000	3000	500

Compound				
Range	Figure interval		Minor graduation	
	in. Hg	psi	in. Hg	psi
30" Hg/15 psi	5	3	1	0.5
30" Hg/30 psi	10	5	1	1
30" Hg/60 psi	10	10	2	1
30" Hg/100 psi	10	10	2	1
30" Hg/150 psi	10	20	5	2
30" Hg/300 psi	30	25	5	5
Vacuum				
Range	Figure interval		Minor graduation	
30/0 in. Hg	5 in.		0.5 in.	

Metric Ranges

Pressure							
kg/cm ² (kilograms per sq. centimeter)	bar	Figure interval	Minor graduation	kPa (kilopascal)	Figure interval	Minor graduation	psi outer scale of dual range*
0/1	0/1	0.1	0.01	0/100	10	1	0/14
0/1.6	0/1.6	0.2	0.02	0/160	20	2	0/22
0/2.5	0/2.5	0.5	0.05	0/250	50	5	0/35
0/4	0/4	0.5	0.05	0/400	50	5	0/55
0/6	0/6	0.5	0.1	0/600	50	10	0/85
0/10	0/10	1	0.1	0/1000	100	10	0/140
0/16	0/16	2	0.2	0/1600	200	20	0/220
0/25	0/25	5	0.5	0/2500	500	50	0/350
0/40	0/40	5	0.5	0/4000	500	50	0/550
0/60	0/60	5	1	0/6000	500	100	0/850
0/100	0/100	10	1	0/10,000	1000	100	0/1400
0/160	0/160	20	2	0/16,000	2000	200	0/2200
0/250	0/250	50	5	0/25,000	5000	200	0/3500
0/400	0/400	50	5	0/40,000	5000	500	0/5500
0/600	0/600	50	10	0/60,000	5,000	500	0/8500
0/1000	0/1000	100	10	0/100,000	10,000	1000	0/14,000
0/1600	0/1600	200	20	0/160,000	20,000	2000	0/22,000
Vacuum							
-1/0	-1/0	0.1	0.01	-100/0	10	1	30" Hg
Compound							
-1/0/1.5	-1/0/1.5	0.05	0.05	-100/0/150	50	5	30" Hg/0/20
-1/0/3	-1/0/3	0.05	0.05	-100/0/300	50	5	30" Hg/0/40
-1/0/5	-1/0/5	0.5	0.1	-100/0/500	50	10	30" Hg/0/70
-1/0/9	-1/0/9	1	0.1	-100/0/900	100	10	30" Hg/0/125
-1/0/15	-1/0/15	2	0.2	-100/0/1500	200	20	30" Hg/0/215
-1/0/24	-1/0/24	5	0.2	-100/0/2400	500	20	30" Hg/0/340

*Inner scale is dominant

Case and ring options	Code	Comments
Hermetically Sealed or Weatherproof Liquid-Fillable Case	LJ	Gauge furnished dry or for liquid filling. Includes a solid fill plug and throttle plug for ranges 30 psi and above.
U-Clamp	UC	Used for panel mounting back-connect gauges.
Front Flange	FF	Includes 3 holes for panel mounting gauges (back-connect only).
Wall Mounting Bracket	BF	Available on 4½" 1009 lower or back-connect."
Back Flange for Wall Mounting	FW	Available on 2½" and 3½" 1009 lower or back-connect.
Retrofit Flange	RF	Available on 63mm and 100mm 1008 back-connect gauges for panel mounting. (Includes U-clamp.)
Metric Gauge	MG	Available on 3½" 1009 with ½ NPT lower connection. Gauge supplied with micrometer pointer, white dial and safety glass.
Bourdon tube and system assembly options		
SS Throttle Plug – (restrictor) Push-in Design	TU	SS push-in type with a 0.013" orifice for 2½", 3½", 100mm 1009, 63mm, 100mm 1008. Throttle plug standard on all 2½", 3½" 1009, 40mm thru 100mm 1008 liquid filled gauges 30 psi-1000 psi
SS Throttle Plug (restrictor) Helical Design	TS	Standard on all 2½", 3½", 100mm 1009s, 40mm, thru 100mm 1008 liquid filled gauges with ranges of 1500 psi and above. 4½", 6" 1009 furnished with thread-in design with a .031" orifice.
Liquid Filled Gauge Without Throttle Plug	WP	Required when the process may clog a throttle plug on the gauge.
Cleaning for Gaseous Oxygen	6B	If gauge is liquid filled specify Halocarbon as the fill or utilize <i>PLUS!</i> Performance (LL).
Liquid filling options		
Silicone Fill	GV	Not available on 40mm and 50mm 1008 gauges.
Halocarbon Fill	GX	Not available on 40mm and 50mm 1008. For oxidizing media. Examples: chlorine, oxygen, nitric acid and sulfuric acid.
Pointer options		
Red Set-Hand (Single)	SH	Available on 1009 only. Single stationary set-hand used to indicate a specific pressure.
Red Set-Hand (Double)	SJ	Available on 1009 only. Double stationary set-hand used to indicate 2 specific pressures.
Red Set-Hand (Adjustable)	EU	Available on 1009 only.
Maximum Pointer	EP	Available on 4½" and 6" 1009 only. Externally reset by a knob on outside of an acrylic window.
Minimum Pointer	EQ	Available on 4½" and 6" 1009 only. Externally reset by a knob on outside of an acrylic window.
Window options		
Polycarbonate Window	PD	Ambient temperature limits –50/270°F. 40mm, 50mm 1008 and 100mm 1009 only. XPD standard on 2½", 3½" 1009 and 63mm and 100mm 1008.
Acrylic Window	PD	4½" and 6" 1009 only. Ambient temperature limits –50/180°F.
Shatterproof Glass	SG	Not available on 63mm, 100mm 1008. Ambient temperature limits –50/200°F.
External Zero Adjustable Pointer (Easy Zero™)	EA	Available in 3½" 1009 with ¼ NPT only. Dry or liquid filled.
Marking and tagging options		
Dial Marking	DA	Service marking printed on dial.
Paper Tagging of Carton and Gauge	NN	Tag is bonded to gauge case and carton.
Stainless Steel Tagging of Gauge Case	NH	300 series stainless steel tag is wired to gauge case.
Calibration options		
Accuracy 0.5% full scale	AN	4½" and 6" 1009 only.
Test and certificate options		
Certificate of Conformance	CD-1	Conformance to specifications and/or drawings.
Individual Certified Calibration Chart	CD-4	
Special connection options		
½ NPT	O1	Available on 2½", 3½" 1009SW.
SAE 7/16" and 20 straight thread	RW	Not available on 40mm, 50mm 1008
7/16" and 20 UNF-3A 37° Flare	EJ	Not available on 40mm, 50mm 1008
¼" straight JIS, BSP	KJ	Not available on 40mm, 50mm 1008
¼" tapered JIS, BSP	KA	Not available on 40mm, 50mm 1008
⅜" straight JIS, BSP	KP	3½", 100mm 1009SW lower connection only
½" straight JIS, BSP	KN	3½", 100mm 1009SW lower connection only
⅜" tapered JIS, BSP	KR	3½", 100mm 1009SW lower connection only
½" tapered JIS, BSP	KQ	3½", 100mm 1009SW lower connection only
G ¼" DIN	13	Not available on 40mm, 50mm 1008

How to Order

Ashcroft® Stainless Steel Case Pressure

Table A – Case selection and mounting

Dial Size	Ordering Code	Case Type	Case: Finish & Material	Ring: Style, Finish & Material	Mounting/Connection
2½", 3½"	(25) (35)	1009	Polished 304 SS	Bayonet, Lock ring	Stem – Lower or back
100mm	(10)	1009	Polished 304 SS	Polished 304 SS	Surface – Lower or back: specify (XFW) back flange Flush – Back: specify front flange (FF) or U-clamp (UC)
4½", 6"	(45) (60)	1009	Polished 304 SS	Bayonet, Lock ring Polished 304 SS	Stem – Lower or back Surface – Lower or back, wall mount bracket (BF) Flush – Back: specify front flange (FF) or U-clamp (UC)
40mm, 50mm	(40) (50)	1008	Polished 304 SS	Push-In, Polished 304 SS	Stem – Lower or back Flush – Back: specify front flange (FF) or U-clamp (UC)
63mm 100mm	(63) (10)	1008	304 SS	Crimped 304 SS	Stem – Lower or back Flush – Back: specify front flange (FF), U-clamp (UC) or retrofit flange (RF)

Table B – System, connection and location

Dial Size	Case Type	Tube and Socket Code	Tube and Socket Material	NPT Conn. and Code	Conn. Location and Code	Range Selection Limits (psi)
(2½", 3½" 100mm)	1009	(AW)	Welded 316 SS tube, bronze socket	(02) ¼ std. (04) ½ opt. ⁽¹⁾	(L) lower (B) back	Vac/1000
		(SW)	Welded 316 SS tube and socket			Vac/15,000
(A)		Grade A phosphor bronze tube, brass tip silver brazed brass socket	(02) ¼ std. (04) ½ opt.	Vac/1000		
(B)		4130 alloy steel tube, 1019 steel socket		Vac/5000		
(R)		316 SS tube, 1019 steel socket		Vac/20,000		
(S)		316 SS tube and socket		Vac/20,000		
(40/50mm)	1008	(S)	316 SS tube and socket	(01) ⅛ std., 40mm ⁽²⁾ (02) ¼ std., 50mm	Vac/15,000	
(63/100mm)		(A)	Phosphor bronze tube, brass socket, soldered	(02) ¼ std.	Vac/6000	
		(S)	Welded 316 SS tube and socket	(02) ¼ std. (04) ½ opt. ⁽¹⁾	Vac/15,000	

NOTES:

(1) 3½"/100mm 1009SW, 100mm 1008S lower connect only

(2) Not available with ¼ NPT

To order an Ashcroft Stainless Steel Case Pressure Gauge (sample coding shown)

Select:	25	1009	SWL	02L	XGV	160 psi
1. Dial size – 2½"	_____					
2. Case type – 1009	_____					
3. Bourdon tube and socket 316SS	_____					
4. Connection – ¼ NPT Lower	_____					
5. Optional features – Silicone filled	_____					
6. Pressure range (see range tables on pages 12 through 14)	_____					

Case Type 1008 – 40mm & 50mm

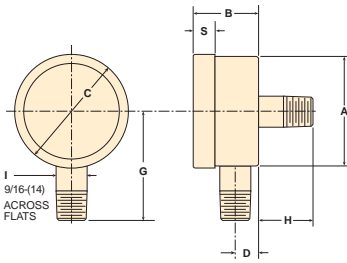

40/50mm lower and back connection

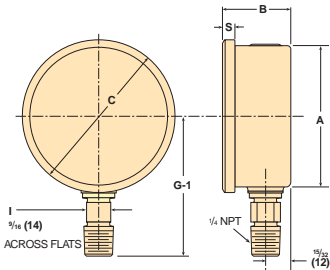

63/100mm 1008S/SL lower connection

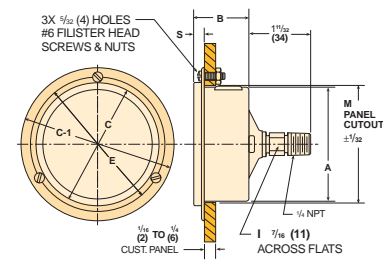

63/100mm 1008S/SL back connection (XFF) Front Flange

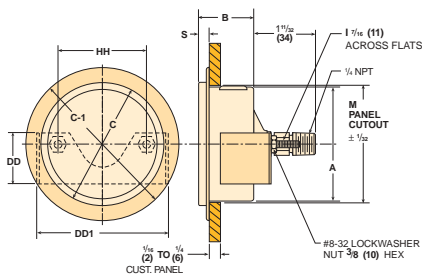

63/100mm 1008S/SL back connection (XRF) Retrofit Front Flange

Case Type 1008 – 63mm & 100mm

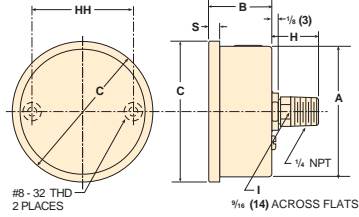

63/100mm 1008A/AL back connection

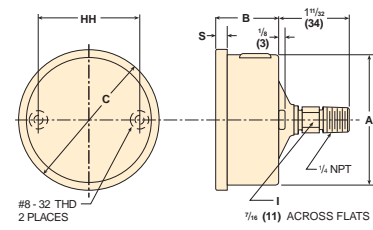

63/100mm 1008S/SL back connection

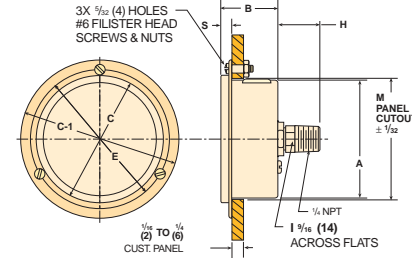

63/100mm 1008A/AL back connection (XFF) Front Flange

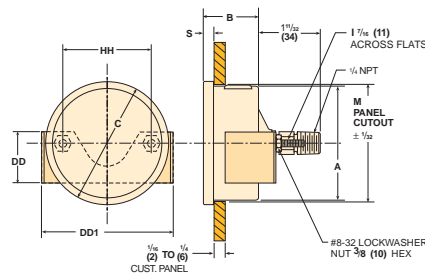

63/100mm 1008S back connection (XUC) U-clamp

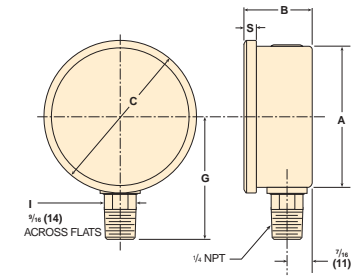

63/100mm 1008A/AL lower connection

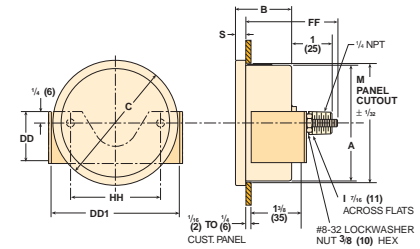

63/100mm 1008A/AL back connection (XUC) U-clamp

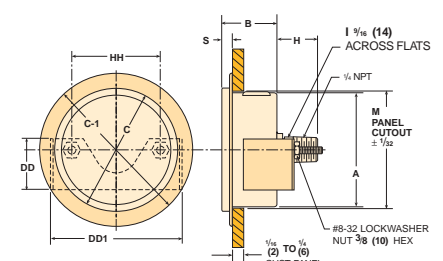

63/100mm 1008A/AL back connection (XRF) Retrofit Front Flange

Case Type 1008S – 100mm with 1/2 NPT

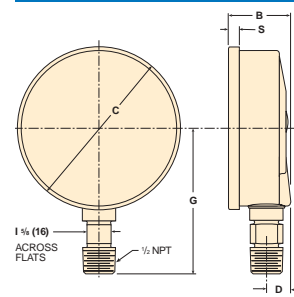

100mm 1008S/SL lower connection

Gauge Size	Dimensions																			Weight	
	A	A-1	B	C	C-1	D	DD	DD1	E	FF	G	G-1	H	HH	I	J	L	M	S	Dry	LF
(40) 1 1/2	(41) 1 5/8		(25) 3 1/32	(42) 1 21/32		(10) 3/8					(43) 1 11/16	(64) 2 1/2	(20) 25/32		(14) 9/16				(8) 5/16	.08kg .17#	.10kg .22#
(50) 2	(52) 2 1/16		(29) 1 1/8	(53) 2 3/32		(10) 3/8					(48) 1 7/8	(64) 2 1/2	(24) 15/16		(14) 9/16				(10) 3/8	.12kg .26#	.17kg .37#
(63) 2 1/2	(63) 2 1/2		(31) 1 7/32	(69) 2 23/32	(86) 3 3/8	(19) 3/4	(29) 1 1/8	(73) 2 7/8	(79) 3 1/8	(46) 1 13/16	(55) 2 5/32	(64) 2 1/2	(23) 29/32	(49) 1 15/16	(11) 7/16	(4) 5/32	(71) 2 3/16	(64) 2 17/32	(6) 1/4	.11kg .25#	.21kg .47#
(100) 3 1/2	(100) 3 15/16	(94) 3 23/32	(31) 1 7/32	(106) 4 5/32	(133) 5 7/32	(22) 7/8	(29) 1 1/8	(106) 4 3/16	(116) 4 7/16	(46) 1 13/16	(86) 3 3/8	(81) 3 3/16	(86) 3 3/8	(76) 3	(11) 7/16	(6) 1/4	(97) 3 3/16	(101) 3 31/32	(6) 1/4	.18kg .40#	.42kg .94#
(100) 1/2 NPT	(100) 3 15/16		(39) 1 17/32	(106) 4 5/32							(94) 3 11/16	(92) 3 5/8			(16) 5/8				(6) 1/4	.23kg .50#	.45kg .97#

Note: Dimensions in brackets () are millimeters.

Dimensions

Ashcroft® Stainless Steel Case Pressure Gauges

Case Type 1009 – 2½" & 3½"

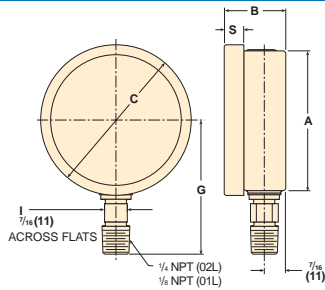

2½" & 3½" 1009 lower connected

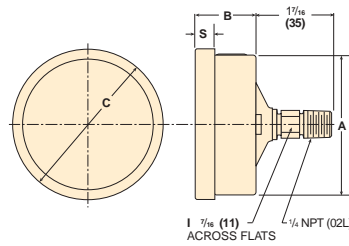

2½" & 3½" 1009 back connected

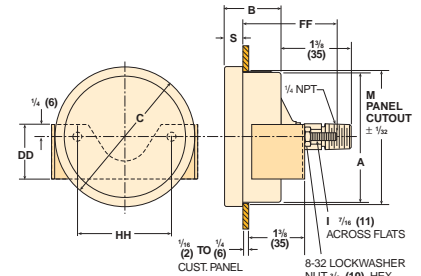

2½" & 3½" 1009 back connected (XUC)

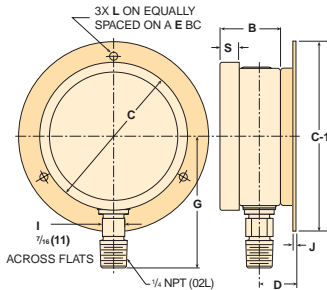

2½" & 3½" 1009 lower connected (XFW)

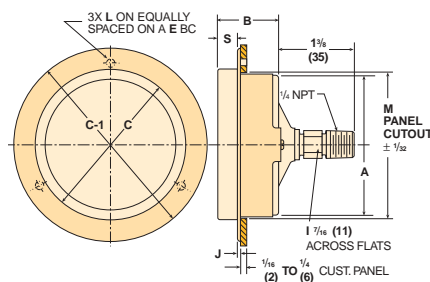

2½" & 3½" 1009 back connected (XFF)

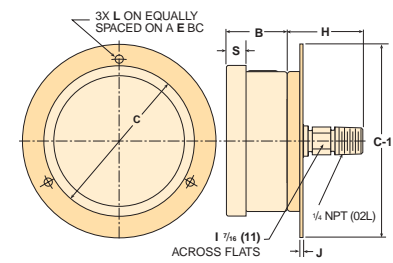

2½" & 3½" back connected (XFW)

Case Type 1009 – 100mm

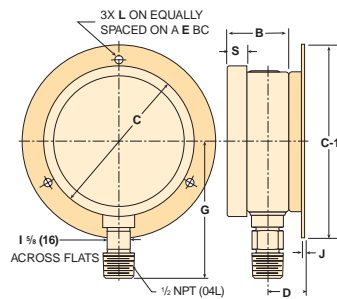

100mm 1009 lower connected (XFW)

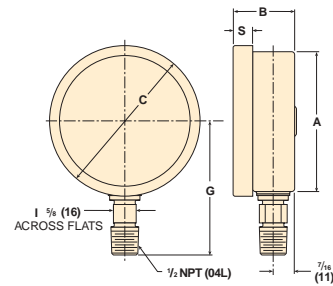

100mm 1009 lower connection

Gauge Size	A	B	C	C-1	D	DD	E	FF	G	H	HH	I	J	L	M	S	Weight	
																	Dry	LF
2½ (63)	2 ²¹ / ₃₂ (67)	1 ³ / ₁₆ (30)	2 ⁷ / ₈ (73)	3 ¹¹ / ₁₆ (94)	³ / ₄ (19)	1 ¹ / ₈ (29)	3 ¹ / ₈ (79)	1 ¹¹ / ₁₆ (43)	2 ⁹ / ₁₆ (65)	1 ³ / ₃₂ (28)	2 ¹ / ₁₆ (52)	7 ¹ / ₁₆ (11)	1 ¹ / ₁₆ (2)	5 ⁵ / ₃₂ (4)	2 ¹¹ / ₁₆ (68)	³ / ₈ (10)	.26# .12kg	.50# .32kg
3½ (100)	3 ¹⁹ / ₃₂ (91)	1 ⁹ / ₃₂ (33)	3 ³¹ / ₃₂ (100)	5 ⁷ / ₃₂ (133)	7 ⁷ / ₈ (22)	1 ¹ / ₃₂ (26.4)	4 ⁹ / ₁₆ (106)	2 ²⁹ / ₃₂ (48)	3 (76)	3 (76)	2 ¹³ / ₃₂ (61)	7 ¹ / ₁₆ (11)	5 ⁵ / ₃₂ (4)	7 ⁷ / ₃₂ (6)	3 ²¹ / ₃₂ (93)	1 ¹⁵ / ₃₂ (12)	.44# .20kg	.88# .40kg
(100)	3 ¹⁹ / ₃₂ (91)	1 ¹⁹ / ₃₂ (40)	3 ³¹ / ₃₂ (100)	5 ⁷ / ₃₂ (133)	7 ⁷ / ₈ (22)		4 ⁹ / ₁₆ (116)		3 ¹¹ / ₁₆ (94)			5 ⁵ / ₈ (16)	5 ⁵ / ₃₂ (4)	7 ⁷ / ₃₂ (6)		1 ¹⁵ / ₃₂ (12)	.50# .23kg	.97# .45kg

Note: Dimensions in brackets () are millimeters.

Case Type 1009 – 4½ & 6

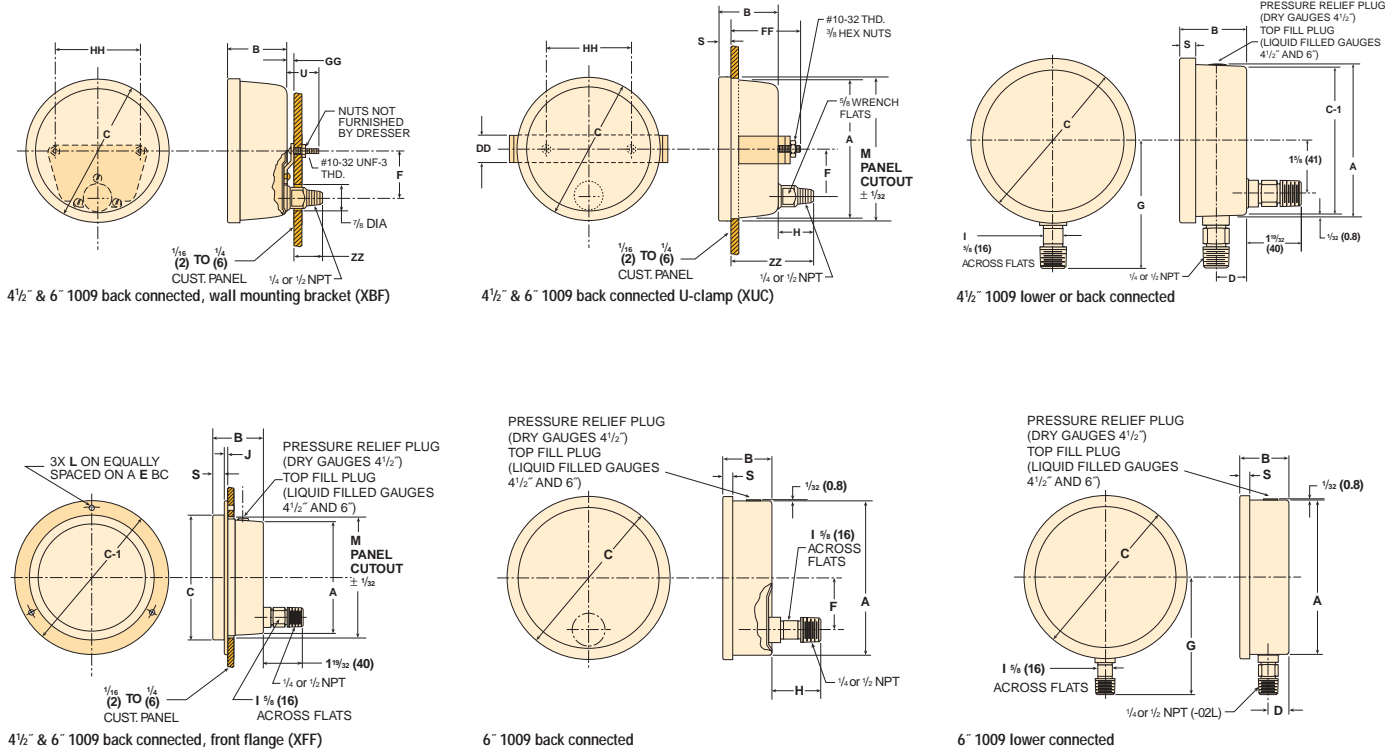

STD.

Gauge Size	Dimensions									Weight	
	A	B	C	D	F	G	I	S	Dry	LF	
4½ (100)	4 ²³ / ₃₂ (120)	2 ¹ / ₁₆ (52)	5 ³ / ₃₂ (129)	1 ⁵ / ₁₆ (24)	1 ⁵ / ₈ (41)	3 ¹⁵ / ₁₆ (100)	5/ ₈ (16)	1 ⁵ / ₃₂ (12)	1.75# .79kg	2.40# 1.1kg	
6 (160)	6 ⁵ / ₁₆ (160)	2 (51)	6 ²¹ / ₃₂ (169)	2 ⁷ / ₃₂ (22)	1 ⁵ / ₈ (41)	4 ¹³ / ₁₆ (122)	5/ ₈ (16)	1 ³ / ₃₂ (10)	2.25# 1kg	4.12# 1.85k	

XFF

Gauge Size	Dimensions										Weight	
	A	B	C	C-1	E	I	J	L	M	S	Dry	LF
4½ (100)	4 ²³ / ₃₂ (120)	2 ¹ / ₁₆ (52)	5 ³ / ₃₂ (129)	6 ⁹ / ₃₂ (160)	5 ¹¹ / ₁₆ (144)	5/ ₈ (16)	5/ ₃₂ (4)	7/ ₃₂ (6)	4 ¹⁵ / ₁₆ (125)	1 ⁵ / ₃₂ (12)	1.75# .79kg	2.40# 1.1kg
6 (160)	6 ⁵ / ₁₆ (160)	2 (51)	6 ²¹ / ₃₂ (169)	7 ⁵ / ₈ (194)	7 ¹ / ₃₂ (179)	5/ ₈ (16)	1/ ₁₆ (2)	1/ ₄ (6)	6 ⁷ / ₁₆ (163)	1 ³ / ₃₂ (10)	2.25# 1kg	4.12# 1.85k

XBF

Gauge Size	Dimensions									Weight	
	A	B	C	F	GG	HH	U	ZZ	Dry	LF	
4½ (100)	4 ²³ / ₃₂ (120)	2 ¹ / ₁₆ (52)	5 ³ / ₃₂ (129)	1 ⁵ / ₈ (41)	3/ ₁₆ (5)	3 (76)	1 ⁷ / ₁₆ (37)	1 ⁷ / ₁₆ (37)	1.75# .79kg	2.40# 1.1kg	
6 (160)	6 ⁵ / ₁₆ (160)	2 (51)	6 ²¹ / ₃₂ (169)	1 ⁵ / ₈ (41)	3/ ₁₆ (5)	4½ (114)	1 ⁷ / ₁₆ (37)	1 ⁷ / ₁₆ (37)	2.25# 1kg	4.12# 1.85k	

XUC

Gauge Size	Dimensions												Weight	
	A	B	C	DD	F	FF	H	HH	I	M	S	ZZ	Dry	LF
4½ (100)	4 ²³ / ₃₂ (120)	2 ¹ / ₁₆ (52)	5 ³ / ₃₂ (129)	1 (25)	1 ⁵ / ₈ (41)	2 ⁵ / ₁₆ (59)	1 ⁵ / ₈ (41)	3 (76)	5/ ₈ (16)	4 ¹³ / ₁₆ (122)	1 ⁵ / ₃₂ (12)	3 ⁹ / ₃₂ (83)	1.75# .79kg	2.40# 1.1kg
6 (160)	6 ⁵ / ₁₆ (160)	2 (51)	6 ²¹ / ₃₂ (169)	1 (25)	1 ⁵ / ₈ (41)	2 ⁵ / ₈ (67)	1 ⁵ / ₈ (41)	4½ (114)	5/ ₈ (16)	6 ⁷ / ₁₆ (163)	1 ³ / ₃₂ (10)	3 ³ / ₁₆ (81)	2.25# 1kg	4.12# 1.85k

Note: Dimensions in brackets () are millimeters.

Instrument Division Sales and Customer Service Locations

U.S. & International Headquarters

Stratford, Connecticut
250 E. Main Street
Stratford, CT 06614-5145
Tel: (203) 378-8281
Fax: (203) 385-0357

U.S. Operations

Industrial Instrument Operations
Stratford, Connecticut
250 E. Main Street
Stratford, CT 06614-5145
Tel: (203) 378-8281
Fax: (203) 381-9042

APG Operations (Control, Transducer and Precision Instruments)
Shelton, Connecticut
Two Research Drive
Shelton, CT 06484
Tel: (203) 925-4000
Fax: (203) 925-4010

Commercial Instrument Operations
Berea, Kentucky
200 Harrison Road
Berea, KY 40403
Tel: (859) 986-9333
Fax: (859) 986-7676

U.S. Sales Offices

Chicago, Illinois Midwest Region
400 W. Lake Street
Suite 318
Roselle, IL 60172-3573
Tel: (630) 980-9030
Fax: (630) 980-9440

Houston, Texas Southwest Region
605 Bel Air Blvd.
Suite 10
Mobile, AL 36606
Tel: (251) 473-1692
Fax: (251) 473-1782

Mobile, Alabama Southeast Region
605 Bel Air Blvd.
Suite 10
Mobile, AL 36606
Tel: (251) 473-1692
Fax: (251) 473-1782

Stratford, Connecticut Northeast Region
250 E. Main Street
Stratford, CT 06614-5145
Tel: (203) 385-0670
Fax: (203) 385-0756

Stratford, Connecticut Pacific Region
250 E. Main Street
Stratford, CT 06614-5145
Tel: (203) 385-0399
Fax: (203) 385-0402

International Operations

Brazil
Dresser Industria e Comercio Ltda.
Rua Senador Vergueiro #433
09521-320 Sao Caetano do Sul
Sao Paulo, Brazil
Tel: 55-11-4224-7400
Fax: 55-11-4224-7477
E-Mail: vendas.instrumentos@dresser.com

Brazil (Jacarei)
Dresser Industria e Comercio Ltda.
Divisao Masoneilan
Rua Particular - Estrada Velha Rio De Janeiro -
Sao Paulo, KM 101 Jacarei,
Sao Paulo Caixa
Postal 167, CEP 12305-330
Tel: 55-11-3958-2011
Fax: 55-11-3958-2670
E-Mail: dresserjac@uol.com.br

Canada
Dresser Canada, Inc.
2135 Meadowpine Blvd.
Mississauga,
Ontario L5N 6L5 Canada
Tel: 905-826-8411
Fax: 905-826-9106
E-Mail: Lance_Barette@dresser.com

China
Dresser Industries, Inc.
Room #2404, Capital Mansion
No. 6 Xin Yuan Nan Road Beijing,
People's Republic of China 100004
Tel: 86-10-84862440/1/2/3/4
Fax: 86-10-84862445
E-Mail: dresser@public3.bta.net.cn

France
Dresser Europe GmbH
74, Rue d'Arceuil
F 95478, France
Tel: 33 (0) 1 60372530
Fax: 33 (0) 1 60372539
E-Mail: dresser.europe@wanadoo.fr

Germany
Dresser Europe GmbH
Postfach 11 20 Max-Planck-Str. 1
D-52499 Baesweiler, Germany
Tel: 49-24-01-8080
Fax: 49-24-01-7027
E-Mail: jbierrmans@dresserbae.de

Germany
Ebro Electronic GmbH
Peringerstr 10D-85055
Ingolstadt, Germany
Tel: 49-84-1-95478-0
Fax: 49-84-1-95478-80
E-Mail: info@ebro.de

Japan
Dresser Japan Ltd.
Room 818, Shin Tokyo Building
3-1 Marunouchi 3-Chome,
Chiyoda-ku, Tokyo, Japan
Tel: 813-3201-1501
Fax: 813-3213-6567
E-Mail: yuichi.yamamoto@dresserjapan.co.jp

Korea

Dresser International, S.A
#2015 Kuk Dong Bldg.
60-1, 3-KA, Choongmu-Ro,
Chung-ku, Seoul, Korea 100-705
Tel: 82-2-2274-0792
Fax: 82-2-2274-0794
E-Mail: dkisjlee@chollian.net

Mexico

Dresser Instruments S.A. De C.V.
Mexico Operations
Henry Ford No. 114
Esq. Foulton Fracc.
Industrial San Nicolas
54030 Tlalnepantla,
Edo De Mexico
Tel: (52)55-53-10-72-17
(52)55-53-10-89-83
(52)55-53-10-28-29
(52)55-53-10-28-75
Fax: (52)55-53-10-26-08
E-Mail: mendiet@avantel.net

Saudi Arabia

Dresser Al Rushaid Valve & Instrument Co. (DARVICO)
P.O. Box 10145
Jubail Industrial City
Saudi Arabia 31961
Tel: 966-3-341-0278
Fax: 966-3-341-7624
E-Mail: bill_dumasja@darvico.com
E-Mail: sam_dastur@darvico.com

Singapore

Dresser Singapore
Instrument Operations
Block 1004 Toa Payoh North
#07-15/17 Singapore 318995
Tel: 65-252-6602
Fax: 65-252-6603
E-Mail: john.wong@dresser.com

United Kingdom

Dresser Europe GmbH
East Gillibrands, Skelmersdale
Lancashire, WN8 9TU
United Kingdom
Tel: 14-16-95-52600
Fax: 14-16-95-52693
E-Mail: Johanna.Gribben@dresser-instrument.co.uk
E-Mail: sales@dresser-instrument.co.uk

Venezuela

Manufactures Petroleras
Venezolanas (M.P.V.)
KM 7 Carretera A El Mojan Calle 18,
#15B355 ZONA Ind. Norte Sector
Canchancha Maracaibo Edo
Zulia Venezuela
Tel: 58-61-579-762/070
Fax: 58-61-579-461
E-Mail: contactenos@mapvensa.com
E-Mail: ventasmpv@telcel.net.ve

Visit our web site
www.ashcroft.com

